

STAFF REPORT

TO: Hailey City Council

FROM: Mariel Platt, Ned Williamson and Tom Hellen

RE: Title 18, Mobility Design and Subdivision Ordinance Amendments

HEARING: October 15, 2012

Note: Staff analysis is in lighter type

Notice

Notice for the public hearing on October 15, 2012 was published in the Idaho Mountain Express and mailed to public agencies and area media on September 26, 2012.

Proposal

The purpose of the amendments includes several aspects:

- Establish procedures, authority and a public process related to street improvements.
- Implement components of Hailey Transportation Master Plan (TMP) involving pedestrian and bicycle infrastructure improvements.
- Update construction standards for streets, water and wastewater infrastructure.
- Bring the Hailey Municipal Code into compliance with Idaho Code §67-6518 related to development standards.
- Provide consistency and accountability, while still remaining flexible.
- Create a public process to improve design and better accommodate all user types and their needs.

Two separate ordinances are proposed to accomplish the above: 1) amendments to Section 1, Definitions and Section 5, Improvements Required of the Subdivision Ordinance and 2) Title 18, a new Title of the Municipal Code. Title 18 contains several sections including Street Design, Street and Drainage Construction, and Water and Sewer Line Construction.

The Council and Mayor reviewed the ordinance amendments and creation of Title 18 on August 6, 2012 and requested that the Planning and Zoning Commission review the changes that were discussed on August 6th and are again highlighted in this memo. The Commission reviewed the proposed ordinance on August 27, 2012 and suggested a few minor changes that have all been incorporated into the attached draft of Title 18. None of the suggested changes were substantive. The Commission has recommended approval of the proposed ordinance.

Sections 18.07 – 18.14 (pages 23-66) are either reserved for future text, or have been reviewed and updated by the Assistant City Engineer. These sections, excluding the reserved sections, currently exist in the Subdivision Ordinance and include the existing City Standard Specifications and Drawings. Minimal changes are proposed; all of which were reviewed by the City Engineer and the Public Works Division Managers for any comments. The most significant change was to rely more heavily on the Idaho Standards for Public Works Construction (ISPWC) for acceptable materials used in construction. The ISPWC is used extensively by cities across

Idaho as a standard that can be relied upon and undergoes a periodic review by a committee of public works officials. The City Engineer does not recommend using only the ISPWC as our standard as we have some differences or specialty items, such as our water meter vaults, which do not match the ISPWC standards exactly. We also specify certain manufacturers for use, especially for water and wastewater infrastructure, to aid us in keeping inventory needs and costs low.

Staff suggests the City Council and Mayor review the attached draft of the ordinance and approve it or continue it to a date certain. Concurrently,

Standards of Evaluation

Section 13.4.2 of the Subdivision Ordinance sets forth the standard of evaluation after receiving a recommendation by the Commission.

1. Will generally conform to the Comprehensive Plan.

The Council should consider how the proposed amendments relate to the goals of the Comprehensive Plan (listed below for the Council's convenience). The following goals have been identified as being the most applicable to this amendment:

Primary:

10.1. Create and maintain a pedestrian and bicycle-friendly community that provides a safe, convenient and efficient multi-modal transportation system for all Hailey residents. The Hailey Transportation Master Plan (TMP) was adopted by the City Council in November 2007 (Resolution 2007-18). The Hailey TMP was developed with consideration of all of the 1998 – 2003 Comprehensive Plan goals and policies related to transportation. The focus of the TMP in turn was the safe and efficient movement of people, while minimizing the adverse impacts of all forms of transportation with recognition of the importance of transportation choices, street design, and land use patterns. The adopted TMP includes recommendations on changes to city standards to increase the safety of bicyclists and pedestrians. The proposed guidelines are intended to implement those recommendations comprehensively with consideration of all of the variables that affect the safety and convenience of different modes while establishing accountability and public involvement.

5.5 Lessen dependency on the automobile.

13.2 Ensure the provision of safe, adequate, convenient multi-modal transportation access to all existing and future school sites.

Related:

3.2 Protect the residential character of the original Townsite

11.1 Establish a built environment that maintains a human scale, retains interest, aesthetics, encourages various levels of interaction among all members of the community, and enhances the character of different neighborhoods. The street design guidelines are intended to reflect what would be the optimal design for safety. However, having flexibility in design is important. The proposed Title 18 establishes guidelines and criteria for reviewing project that allow for flexible design to best balance user needs.

12.1 Evaluate whether proposed regulatory or administrative actions may result

in an unconstitutional taking of private property. There is no indication the amendments will result in an unconstitutional taking of private property.

Comp Plan Goals
1.1 Preserve, protect and restore natural resources including waterways, floodplains, wetlands, soil, community forest, native vegetation, green space and wildlife habitat and migration corridors for the benefit of the City and its residents.
1.2 Efficiently use and conserve resources.
1.3 Promote renewable energy production
1.4 Promote energy conservation
1.5 Promote air quality protection
2.1 Reduce the potential threat to loss of life, limb or property and minimize public expenditures due to natural and man-made hazards.
3.1 Assure the protection and preservation of Special Sites, Areas and Features to maintain a strong community identity for future generations
3.2 Protect the residential character of the original Townsite.
4.1 Create and maintain an interconnected system of parks, recreational facilities, trails, green spaces and natural lands in order to provide diverse recreation opportunities for Hailey residents within ¼ mile to ½ mile of the greatest number of residents.
5.1 Retain a compact City comprised a central downtown with surrounding diverse neighborhoods, areas and characteristics as depicted in the Land Use Map:
a. Main Street Corridor – area of high density commercial, mixed use and residential development.
b. Downtown - the historic commercial center containing the greatest concentration of commercial, cultural and civic activity. Downtown is the priority area for encouraging higher density commercial and mixed use (commercial and residential) development.
c. Community Activity Areas – located at the north and south ends of the Main Street Corridor. High density residential is encouraged. Commercial and mixed use (commercial and residential) development is appropriate, but should be subordinate and secondary to the infill of Downtown.
d. High Density Residential – high density residential infill is encouraged in the area along Main Street and River Street between Downtown and the north and south ends of Main Street.
e. Residential Buffer – medium density residential, providing a buffer between lower density residential neighborhoods to the east and west and the Main Street District.
f. Traditional Residential – Density varies depending on the qualities of different neighborhoods, generally density is higher within a ¼ mile of Downtown, Community Activity Areas or Neighborhood Service Centers and connected by transit service.
g. Neighborhood Service Centers – Small commercial areas serving residents within walking distance (¼ to ½ mile) where commercial use is subordinate to residential uses and to Downtown or Community Activity Areas.
h. Light Industrial – Areas containing uses important to a variety of business sectors that focus on the production of products and services that are less compatible with, and do not compete with, uses in Downtown and the Community Activity Areas.
i. Airport Site Redevelopment – a diversity and integration of uses and community assets that complement and support Downtown and are connected within and to existing neighborhoods.

j.	Community Gateways – areas where one has a sense of arrival or sense of being within a part of town distinguished from others providing opportunities for special design considerations.
5.2	Maintain Downtown as the area containing the greatest concentration of commercial, cultural and civic activity and as the priority area for encouraging higher density commercial and mixed use (commercial and residential) development.
5.3	Continue cooperation with the Blaine County and the Friedman Memorial Airport Authority in regional planning efforts to optimally relocate the airport and plan for the long term redevelopment of the site within the city limits to ensure that changes in land use are beneficial to the community of Hailey.
5.4	Protect open space within and surrounding Hailey, including visible ridgelines, undeveloped hillsides and agricultural areas which help define the unique character of Hailey.
5.5	Lessen dependency on the automobile.
5.6	Manage and accommodate population growth by infill development and, when appropriate, minimal expansion by annexation and/or density increases.
5.7	Encourage development at the densities allowed in the Zoning Code.
6.1	Encourage a diversity of economic development opportunities within Hailey
6.2	Encourage abundant, competitive and career-oriented opportunities for young workers.
7.1	Encourage a variety of projects and programs that meet the needs generated by various segments of the population, especially the needs of those who risk suffering effects of discrimination or are socially or economically disadvantaged.
7.2	Encourage projects and programs that seek to provide opportunities for cultural, cross-cultural and educational enrichment.
8.1	Encourage development that provides opportunities for home ownership and rental homes for individuals and families of all socio-economic levels.
9.1	Plan for the long-term utilities, service and facility needs of the City while minimizing impacts to the greatest extent possible.
10.1.	Create and maintain a pedestrian and bicycle-friendly community that provides a safe, convenient and efficient multi-modal transportation system for all Hailey residents.
11.1	Establish a built environment that maintains a human scale, retains interest, aesthetics, encourages various levels of interaction among all members of the community, and enhances the character of different neighborhoods.
12.1	Evaluate whether proposed regulatory or administrative actions may result in an unconstitutional taking of private property.
13.1	Encourage and facilitate the development of school facilities that are planned consistently with the city's other land use policies.
13.2	Ensure the provision of safe, adequate, convenient multi-modal transportation access to all existing and future school sites.

2. Will not create excessive additional requirements at public cost for public facilities and services.

For city initiated projects, the street standards are applied when there is funding available for projects to be constructed. It does not require that the city initiate any projects, as a result of the creation of Title 18.

There are existing street improvement and construction standards that currently apply as a result

of city zoning or subdivision requirements. These construction standards are currently located in the Subdivision Ordinance. Attached is an ordinance to amend the Subdivision Ordinance to move these construction standards to Title 18.

Currently, when a property owner constructs a new commercial building in the city or new residence in the townsite area or creates a new subdivision the zoning and subdivisions standards require sidewalk improvements. Given that the requirements already exist, it is not anticipated that Title 18 would require additional costs. Title 18 would only provide further guidance on what is appropriate for various streets and neighborhoods in Hailey, in a flexible and thoroughly reviewed manner.

3. Will be in accordance with the welfare of the general public.

The city currently has standards for street design and construction, which the adopted Transportation Master Plan suggested were in need of updating with consideration of design practices that better address pedestrian and bicycle safety. The intent is, over time (decades most likely) with the implementation of the new procedures, process and standards, the city will have a safe, convenient and connected network of streets and sidewalks for all transportation modes.

Summary

The Council is required to hold a public hearing and determine whether the amendments meet the standards of evaluation.

If the proposed amendment is approved, the Council shall pass an ordinance making the amendment part of Hailey Subdivision Ordinance #821 and creating Title 18, Mobility Design. The draft ordinances are attached.

Motion Language

Approve:

Motion to approve proposed amendments Subdivision Ordinance Section 1 and 5 and the new Municipal Code Title 18 and conduct the first reading.

Denial:

Motion to deny the proposed amendments Subdivision Ordinance Section 1 and 5 and the new Municipal Code Title 18, finding that _____ [the Council should cite which criteria are not met and provided the reason why each identified criteria is not met].

Continuation:

Motion to continue the public hearing upon the proposed amendments Subdivision Ordinance Section 1 and 5 and the new Municipal Code Title 18 to _____ [the Council should specify a date].

Table:

Motion to table the public hearing upon the proposed amendments Subdivision Ordinance Section 1 and 5 and the new Municipal Code Title 18.

HAILEY ORDINANCE NO. _____

AN ORDINANCE OF THE CITY OF HAILEY, IDAHO, AMENDING THE HAILEY MUNICIPAL CODE, BY ADDING A NEW TITLE, TITLE 18, MOBILITY DESIGN, TO ESTABLISH PROCEDURES FOR DESIGN, CONSTRUCTION AND RECONSTRUCTION OF STREET INFRASTRUCTURE AND TO CREATE STREET DESIGN GUIDELINES AND STANDARDS; PROVIDING FOR A SEVERABILITY CLAUSE; PROVIDING FOR A REPEALER CLAUSE; AND PROVIDING FOR THE EFFECTIVE DATE OF THIS ORDINANCE UPON PASSAGE, APPROVAL AND PUBLICATION ACCORDING TO LAW.

WHEREAS, designing and operating streets with all users in mind - including bicyclists, transit vehicles and passengers and pedestrians of all ages and abilities is considered by the City of Hailey as a best practice and serves as the basis to comprehensively develop street design standards to appropriately address multi-modal needs and enable safe access for all users in a context sensitive manner;

WHEREAS, the 1998-2003 Hailey Comprehensive Plan includes goals and policy statements that embody these best practices principles, such as, “Ensure an interconnected community that provides multi-modal access to all neighborhoods.”

WHEREAS, the City of Hailey 2007 Transportation Master Plan (TMP) is intended as the City’s implementation of the 1998-2003 Hailey Comprehensive Plan Transportation section and provides the City with a guide for transportation system improvements to meet existing and future travel needs. The purpose of the TMP is to provide a link between the City’s land use assumptions and the transportation facilities and services needed to support the growth projected over a 20 year period. The TMP focuses on safety, capacity, and operational improvements on SH-75 and the city’s arterial and collector streets. The TMP incorporates pedestrian and bicycle programs to meet the overall transportation needs of the community. Appendix E of the TMP identified needed revisions to the City’s street standards for consistency with the most recent federal bicycle and pedestrian standards and policies;

WHEREAS, the purpose of the street design standards is to implement components of the TMP involving pedestrian and bicycle infrastructure improvements by setting the framework to formally adopt the following:

- Standards for pedestrian and bicycle infrastructure projects,
- Process for engaging the public in the development of pedestrian and bicycle infrastructure projects, and
- Procedure for project design, review and approval;

WHEREAS, the Hailey City Council has found that the following amendment to the Hailey Municipal Code will generally conform to the Hailey Comprehensive Plan;

WHEREAS, the amendments will not create excessive additional requirements at public cost for public facilities and services;

WHEREAS, the proposed uses are compatible with the surrounding area; and

WHEREAS, the amendment will be in accordance with the safety and welfare of the general public.

NOW, THEREFORE, BE IT ORDAINED BY THE MAYOR AND CITY COUNCIL OF THE CITY OF HAILEY, IDAHO, AS FOLLOWS:

Section 1. The Hailey Municipal Code is hereby amended by the addition of a new Title 18, Mobility Design, as follows:

Title 18

Mobility Design

Chapters:

- 18.04 Procedures
- 18.06 Street Design
- 18.07 Transit Stop Standards - reserved
- 18.08 Street and Drainage Construction
- 18.10 Water and Sewer Line Construction
- 18.12 Excavation and Backfill
- 18.14 Standard Drawings

Chapter 18.04

Procedures

Sections:

- 18.04.010 Purpose
- 18.04.012 Applicability
- 18.04.014 Exemptions
- 18.04.015 Definitions
- 18.04.016 Administration
- 18.04.018 Submittal Requirements and Review Procedure
- 18.04.020 Amendment

18.04.010 Purpose. This ordinance is enacted to provide a uniform set of standards and procedures for Infrastructure Projects, to update Hailey street design standards to adequately address and promote multi-modal needs and safe access for all users, including pedestrians, bicyclists, motorists and transit vehicles and passengers, to establish a process for project design which provides flexibility and accountability, balances the safety and convenience of all users of the transportation system in the design, operation, maintenance, construction and reconstruction of new and existing Infrastructure Projects, considers whether people of all ages and abilities are able to travel safely and comfortably within the right-of-way of public and private streets, and considers how design variations may affect the safety and convenience of certain user groups.

18.04.012 Applicability. Unless otherwise exempted or as otherwise stated herein, the guidelines and standards of this Title 18 shall apply to any design, construction or reconstruction of Infrastructure Projects within the jurisdiction of the City of Hailey. For any Large Subdivision application, all guidelines identified herein shall be treated as standards.

18.04.014 Exemptions. Ordinary maintenance activities designed to keep assets in serviceable condition including but not limited to mowing, cleaning, sweeping, chip sealing, fog coating, or spot repair, and emergency Infrastructure Projects necessary to guard against imminent peril, are exempt from the provisions of this Title 18.

18.04.015 Definitions. For the purpose of this ordinance, the capitalized terms have the following meanings:

Administrator. The person designated by the Mayor or City Administrator to oversee the administration of this Title.

Bicycle Facilities (or Infrastructure). Improvements and provisions that accommodate or encourage bicycling, including parking and storage facilities, and shared roadways not specifically defined for bicycle use.

Bicycle Lane. A portion of a roadway that has been designated by signs and pavement markings for preferential or exclusive use by bicyclists. Bicycle lanes are facilities that are placed on both sides of a street, and they carry bicyclists in the same direction as adjacent vehicle traffic. In addition to lane striping, pavement and signage identify lanes.



Bikeway. Any road, street, path that in some manner is specifically designated for bicycle travel, regardless of whether such facilities are designated for the exclusive bicycle use or are to be shared with other travel modes.

City. The City of Hailey, Idaho.

City Engineer. The City Engineer of Hailey, Idaho, or his representative, or an authorized Consulting Engineer acting within the authority delegated to him by the City.

City Standards. Those standards for improvements as set forth in the “City of Hailey Improvement Standard Drawings” and “Standard Specifications” adopted in Section 5 of the Hailey Subdivision Ordinance.

Commission. The Planning and Zoning Commission of the City of Hailey, Idaho.

Contractor. An individual, partnership, firm or corporation executing a contract, acting directly under the Owner/Developer and who is primarily responsible for the acceptable performance of the construction.

Council The Hailey City Council.

Drawings of Record. The official drawings and supplemental drawings or exact reproductions thereof, showing the location, dimensions, elevations, and details of the work as completed.

Engineer. A registered engineer in the State of Idaho acting on behalf of and under the direction of the Owner/Developer.

Infrastructure Project. Construction or reconstruction of infrastructure within the right-of-way or on a private street for the benefit of the public, including but not limited to streets, sidewalks, drainage, flood control structures, traffic control, landscaping, bridges, water and wastewater systems. Infrastructure Projects may be funded with public or private funds.

Owner/Developer An individual, partnership, corporation, municipality, or other division of government acting in his/her/its own behalf or through legally authorized officials.

Paved Shoulder. A paved area adjacent to the travel lane and separated from travel lanes with a lane stripe. This facility is typically applied to a rural cross-section that does not have curb and gutter.

Shared Lane. The portion of a street used by both motorized vehicles and bicycles. Street with Shared Lanes may be undesignated or designated bike routes. The formal designation and signing of a street with a Shared Lane should indicate to bicyclists that particular advantages exist to using the routes compared to other routes.



Shared-Use Path. A Bikeway physically separated from motorized vehicular traffic by an open space or barrier, and is either within the highway right-of-way or within an independent alignment. Shared-use paths are also used by pedestrians (including skaters, users of manual and motorized wheelchairs, and joggers) and other authorized motorized and non-motorized users. The Wood River Trail is a Shared-Use Path.



Sharrow. A pavement marking used on shared travel lanes to indicate significant bicycle traffic to both the motorists and cyclists.



Sidewalk Corridor. The portion of a street right-of-way designed for preferential or exclusive use by pedestrians and generally begins at the edge of the vehicular travel lane and ends at the property line, along the sides of streets between street corners.

Source: San Francisco's Shared-Lane Pavement Marking Study, February 2004

Large Subdivision. A parcel of real property subject to an application under Hailey's Subdivision Ordinance, which does not qualify for a Short Plat procedure, provided the subdivision application proposes a new public or private street. For the purpose of this definition, a parcel of real property subject to an application under Hailey's Subdivision Ordinance shall mean one or more contiguous parcels of real property owned by one individual or entity with a base density of five (5) or more lots for a residential parcel and three (3) or more lots for a non-residential parcel for the applicable zoning district(s).

Standards and Test Methods. All specifications and test methods of any society, association or organization herein referred to shall be the latest standards and tentative standards that may be in force at the time the plans are approved, including but not limited to:

- AASHTO - The American Association of State Highway and Transportation Officials.
- ANSI - American National Standards Institute (formerly ASA - American Standards Association)
- ASTM - The American Society for Testing Materials.
- AWWA - American Water Works Association
- ISPWC - Idaho Standards for Public Works Construction
- ITD - Idaho Transportation Department

18.04.016 Administration.

A. Duties. The duties of the Administrator or his/her designee shall include, but not be limited to ensuring Infrastructure Projects meet the applicable standards and complying with the procedural requirements of this Title 18 and reviewing, approving and documenting any exemptions from applicable standards.

B. Authority of Administrator. The Administrator has the authority to review and recommend decisions as follows:

1. Those applications for projects meeting the criteria for an exemption set forth in Section 18.04.014. All approved exemptions must be documented in a memo to the project file.

2. The Administrator has the authority to approve minor modifications to projects that have received approval by the Council prior to, and for the duration of the project construction. Minor modifications include, but are not limited to changes in curb ramp designs that meet the standards specified herein, tree species changes with approval of the Hailey Tree Committee, bicycle rack placement changes that meet the bicycle rack standards specified herein, and other changes with a similar degree of modification. The Administrator shall make the determination as to what constitutes a minor modification. All approved modifications must be documented in a memo to the project file and on the approved set of Drawings of Record. For modifications to projects that are determined by the Administrator not to be minor, the Administrator shall submit findings of fact and conclusions of law to the Council on its consent agenda. If an applicant wishes to obtain approval of a modification determined not to be minor, the applicant may file an application to modify a prior approval, which application will be reviewed in accordance with this Title 18.

18.04.018 Submittal Requirements and Review Procedure

A. Application Procedure.

1. A party seeking the construction of an Infrastructure Project shall submit to the Administrator an application on a form provided by the Administrator. The application shall include any proposed plat, plan and profile for streets, water mains and services, sanitary sewers and services, hydrant locations, storm drain plans and calculations, and may also include an erosion control plan, snow storage calculations, traffic study and traffic control plan.

2. Review of an Infrastructure Project is initiated by the submittal of plans that are substantially complete. The design plans submitted shall be submitted by a registered engineer and shall conform to the requirements of this Title 18, the Hailey Subdivision or Zoning Ordinance, if applicable, and any conditions of approval. The seal of the registered engineer responsible for preparation of the plans shall appear on each sheet.

3. Following review, the plans may be returned insufficient with comments and deficiencies noted. Further review shall be dependent upon the Engineer responding to each comment, deficiency or condition of the prior review. Any supplemental specifications that the Owner/Developer or Administrator determines are necessary for the proper construction of a specific project shall be provided at the Owner/Developer expense.

B. Hearing Procedure.

1. The Administrator shall schedule a date for a public hearing to consider the application for the Infrastructure Project. The hearing shall be the same as the public hearing noticed for a zoning or subdivision (design review, PUD or subdivision) application which requires approval of one or more components of the Infrastructure Project.

2. The Administrator shall mail to each addressee on the list furnished by the applicant a copy of the time and place of the hearing at least fifteen (15) days prior to the date scheduled for the hearing. When notice is required to be provided to two hundred (200) or more property owners or purchasers of record, alternate forms of notice may be provided in lieu of mailed notice. Sufficient notice shall be deemed to have been provided if the City provides notice through a display advertisement of at least four (4) inches by two (2) columns in size in the official newspaper of the City at least fifteen (15) days prior to the hearing date. Notice of such hearing shall also be mailed to other political subdivisions. At least one (1) week prior to the hearing, notice shall be posted at each intersection along the streets being improved to inform people who live on or

otherwise use the street. Posted notice shall state the time and place of the hearing and describe project location, basic elements of project, timing, grant information, other relevant information and solicit input.

3. In the event the Commission reviews a zoning or subdivision application which involves an Infrastructure Project, the Commission shall first make a recommendation to the Council to deny, approve or conditionally approve the application for the Infrastructure Project. The recommendation by the Commission shall be heard by the Council as a de novo hearing at the next available regular Council meeting after the Commission's findings of fact, conclusions of law and recommendation are signed by the Commission. In the event the Commission's action on the underlying zoning or subdivision application is a final decision, the Commission, in its sole discretion, may delay the effective date of any approval until the Council makes a final decision on the application for Infrastructure Project.

4. In the event an Infrastructure Project does not involve a zoning or subdivision application, the Council shall conduct a public hearing on the application for an Infrastructure Project, subject to the notice requirements set forth in Section 18.04.018(B)(2), above.

5. The Commission and Council shall evaluate each application for an Infrastructure Project based on the guidelines and standards set forth in this Title 18.

C. Pre-Construction.

1. Construction plans for all Infrastructure Projects may be prepared after City approval and shall be prepared by a registered engineer prior to any construction. The seal of the registered engineer responsible for preparation of the plans shall appear on each sheet.

2. The Administrator shall schedule a pre-construction meeting to be held prior to the start of construction with the Owner/Developer and/or his Engineer, city staff and the Contractor. The purpose of the meeting is to discuss the construction schedule, inspection requirements and any items of work that require special coordination with the City. The Administrator shall request that 5 sets of final construction plans be delivered to the City at least one (1) week prior to a pre-construction meeting.

3. Any work, which will affect the movement or safety of vehicles, bicycles or pedestrians, will require submittal of a traffic control plan at least one (1) week prior to the pre-construction meeting. All traffic control devices shall be continuously maintained for the duration of construction, including nights and weekends, and until the right-of-way is free of construction hazards.

D. Construction.

1. All Infrastructure Projects shall be constructed or reconstructed in accordance with City Standards.

2. All testing and inspection shall be at the Owner's/Developer's or his designated Contractor's expense. A registered engineer or his authorized agent acting on behalf of and under the direction of the Owner/Developer shall perform all inspections.

3. All construction shall be scheduled so that a minimum of inconvenience will result to the public. Where irrigation systems are encountered, normal water flow shall not be interrupted unless approved in advance in writing by all parties affected.

4. Within 30 days from completion of the project, Drawings of Record shall be submitted to the City Engineer. Three (3) complete sets shall be required for water and sewer construction, and two (2) sets for street and drainage construction. Drawings of Record shall include, but are not limited to, the actual dimensions from property corners or other permanent monuments to sewer and water services.

18.04.020 Amendment. Pursuant to Idaho Code § 67-6518, amendments to this Title are required to be noticed according to the procedures set forth in Idaho Code § 67-6509, including a public hearing before the Commission and the Council and notice of each of the hearings at least fifteen (15) days prior to the hearing.

Chapter 18.06

Street Design

Sections:

- 18.06.010 Street Classifications, Types and Designation
- 18.06.012 Street Design Guidelines and Standards
- 18.06.016 Traffic Calming Guidelines and Standards
- 18.06.022 Pedestrian Facility Design Guidelines and Standards
- 18.06.024 Bicycle Facility Design Guidelines and Standards
- 18.06.026 Street Tree Guidelines and Standards
- 18.06.028 Streetscape Elements Guidelines and Standards

18.06.010 Street Classifications, Types and Designations.

A. Street Classification. Streets within the City are classified as arterials, collectors or local. Each Street Classification is described in the following table:

	Arterial	Collector	Local
Functions	<ul style="list-style-type: none"> • Provides regional connections. • Serves major business areas. • Serves truck routes. 	<ul style="list-style-type: none"> • Connects to major arterials and commercial centers. • Serves some truck routes. • Collect neighborhood traffic and feed it into other collectors and arterials. • Access to schools, parks, etc. 	<ul style="list-style-type: none"> • Access to individual properties. • May provide on-street parking.
Access Control	Partially controlled	Limited to abutting lots not fronting on local streets	Relatively unlimited
Typical Daily Volume	Over 10,000	500 to 2,000	Under 1,000
Managed Speed	25-55 mph	20-35 mph	20-25 mph

A street's classification may be revised if the typical daily volume changes over time or may be revised based on reasonable anticipated uses which would use the street.

B. Street Type. Streets within the City are categorized as Business, Residential or Transition. A street's type may be revised if the zoning changes over time or may be revised based on reasonable anticipated zoning changes.

C. Street Designations. Streets within the City may be designated as truck routes, school connections or bicycle corridors. A street's designation may be revised if the City of Hailey Transportation Master Plan (TMP) changes over time or may be revised based on reasonable anticipated changes to the TMP.

D. The following table lists the classification, type and designation of each street within the City. Figure 1 is a map of these classifications, types and designations with the historic sidewalk district.

	ROW width	Arterial	Business Collector	Business Local	Transition Block	Residential Collector	Truck Route	School Connection	Bicycle Corridor
east/west									
McKercher Blvd	80					X			X
Myrtle St	100					X		X	X
Spruce St	100		River to Main		Main to First				

Silver St	100		River to Main		Main to First				
Galena St	100		River to Main		Main to First				
Carbonate St	100		River to Main		Main to First				
Bullion St	100		River to First		First to Second	X			X
Croy St	100		River to First		First to Second	X			X
Quigley Rd	80					X			X
Walnut St	100		River to First		First to Second				
Pine St	100		River to First		First to Second				
Elm St	100					X		X	X
Maple St	100								
Cedar St	100					X			
W. Cedar St	100								X
Fox Acres Rd	80					X			X
north/south									
River St	100								X
Main St	80	X					X		X
Broadford Rd	60								X
Airport Way	60		X						X
First Ave	100		Carbonate to Pine		Pine to Elm				
Second Ave	100					X		X	X
Fourth Ave	100		Maple to Main					X	
Eastridge	80					X			
Woodside Blvd	80					X		X	
Glenbrook Dr	60			south of Woodside		north of Woodside			
Black Oak Dr	60			X					
Mountain Dr	60			X					

Any street, or portion of a street, not listed in the above table is designated as a Residential/Local street.

E. Special Designations.

1. Bicycle Corridors.

a. The streets designated as bicycle corridors streets provide connection to other bicycle facilities, are preferred routes for bicyclists or provide connection to destinations such as a park, school, other neighborhoods or a commercial area. These streets should be improved with a Sharrow or Bicycle Lane and signed as Bicycle Routes as funds become available and allocated by Council.

b. Signed Bicycle Routes.

i) Bicycle corridors should be signed as bicycle routes when the following criteria are met:

(1) shoulder or lane widths meet or exceed minimum Shared Lane widths;

(2) street parking has been removed or restricted in areas of limited width to provide improved safety for bicyclists; and

(3) a smooth surface has been provided, including but not limited bicycle safe drainage grates and potholes filled.

ii) Signs should be placed every 500 meters (1/4 mile), at every turn and at signalized intersections.

iii) Signs shall meet MUTCD standards and include supplemental destination plates, to inform cyclists of route continuity and major destinations and attractions, such as "To Downtown".

iv) Sharrow pavement markings should be applied to the pavement at reasonable intervals.

2. Transition Blocks. The half block between residential and business zoning of the streets identified in the Table in Section 18.06.010(D), above, are transition blocks, except if located within the Historic Sidewalk District. Consideration should be given to vary the design of Infrastructure Projects to best match the design on either side of the transition block.

3. Wood River Trail Crossings. Street design adjacent to the Wood River Trail Crossing should transition to sidewalks with curb and gutter at the edge of the travel lane. Width of sidewalk in the transition to the Wood River Trail Crossing should increase to a minimum of eight feet (8').

4. Historic Sidewalk District.

The blocks within the original Hailey Townsite identified on Figure 1 in Section 18.06.010(D) are included in the Historic Sidewalk District. The City should plan for the connection of the sidewalks in the Historic Sidewalk District through the corners and plan for the maintenance of these sidewalks to eliminate hazards and keep the Pedestrian Zone clear of encroaching vegetation.

18.06.012 Street Design Guidelines and Standards.

A. General. Street Design shall be appropriate to the context and function of the street and the surrounding neighborhood, and shall recognize that balancing user needs and flexible design may be achieved in different ways depending on the area in which the street is located and its classification, type and designation.

B. Factors. The following factors affecting pedestrian and bicycle safety shall be considered when determining the appropriate street design.

1. Front in angle parking is hazardous for bicyclists riding in the street due to drivers' vision being limited while backing out of a space.
2. Parallel parking provides a buffer between pedestrians and moving cars in the travel lane.
3. Parallel parking is hazardous for bicyclists riding in the street due to doors opening suddenly.
4. Parallel parking results in fewer spaces than perpendicular parking.
5. Bicyclists on sidewalks increases potential for collisions at driveways and intersections, which are frequent throughout Hailey, due to the fact bicyclists on sidewalks are farther away from the driver's line of sight and therefore less visible to the driver.
6. Wide sidewalks on both sides of the street gives less confident bicyclists an area that "feels" safe; it is important to reinforce safe biking techniques particularly biking on the right side of the street, in the same direction as vehicles on the street.
7. Sidewalks on both sides of the street provide pedestrians convenient and safe access to more destinations by providing space separated from bicyclists and motor vehicles and by minimizing street crossings.

C. Sidewalk Zone, Bicycle Facilities, Parking and Drainage. The following table recommends a minimum allocation of space for each mode to maximize the safety of pedestrians and bicyclists, and recommends the type of parking and drainage. When determining the appropriate allocation of space on a street §§18.06.012(A) and (B) should be considered.

	Sidewalk Zone (includes curb, buffer, ped & frontage zones) – both sides of street	Bicycle Facilities – both sides of street	Parking	Drainage
Business/Collector 100' ROW	16 ft total width with min 5 ft ped zone	12 - 14 ft Shared Lane with Sharrow	60° angled	Concrete curb and gutter
Business/Collector 60' ROW	6 ft total width with min 5 ft ped zone and 1 ft curb zone	10 - 12 ft Shared Lane with Sharrow	10' wide parallel	Concrete curb and gutter
Business Local 60' ROW	9 ft wide shoulder located left of a wide fog line	10 - 12 ft Shared Lane with Sharrow	Parallel allowed in shoulder, no stripping necessary	Concrete valley gutter
Residential/Collector 80' or 100' ROW	17.5 total width with min 7 ft ped zone, consider 10 ft ped zone on school connections	10 - 12 ft Shared Lane with Sharrow or 5 ft Bicycle Lane	May vary based on needs or neighborhood and ROW width	Natural swale
Residential/Collector 60' ROW	15 ft total width with min 7 ft ped zone	10 - 12 ft Shared Lane with Sharrow or 5 ft Bicycle Lane	Parallel is preferred	Natural swale
Residential/Local 60' or 100' ROW	11 ft total width with Min 5 ft ped zone	10 - 12 ft Shared Lane with Sharrow	May vary based on needs or neighborhood and ROW width	Natural Swale

D. Business/Collector Streets. Except as otherwise provided herein, drought tolerant landscaping, irrigation, bike racks and streetscape elements approved by the City should be installed within the Buffer Zone on Business/Collector streets with right-of-way widths of 100 feet.

1. For City funded projects, drought tolerant landscaping and irrigation should be planned and included in the overall project budget. If funds for the installation and maintenance of landscaping are not available due to budget constraints, then at a minimum irrigation infrastructure should be installed to enable landscaping to be installed and maintained at a later date.

2. Streetscape elements may be located in the Buffer or Frontage Zones.

E. Residential/Collector Streets. Except as otherwise provided herein, landscaping and irrigation should be installed on Residential/Collector streets with right-of-way widths of 80 or 100 feet.

1. For City funded projects, drought tolerant landscaping and irrigation should be planned and included in the overall project budget. If funds for the installation and maintenance of drought tolerant landscaping are not available due to budget constraints, then at a minimum irrigation infrastructure should be installed to enable drought tolerant landscaping to be installed and maintained at a later date.

18.06.016 Traffic Calming

A. Measures. The following traffic calming measures are acceptable for the Street Type and Classification indicated in the following table:

	Collector	Local
Business	<ul style="list-style-type: none"> • Stop Signs • Neckdowns and Chokers • Roundabouts • Bulbouts 	<ul style="list-style-type: none"> • Raised Intersections • Speed Humps • Chicanes/Lateral Shifts • Neckdowns/Chokers • Neighborhood Roundabouts
Residential	<ul style="list-style-type: none"> • Stop Signs • Neckdowns and Chokers • Roundabouts 	<ul style="list-style-type: none"> • Raised Intersections • Speed Humps • Chicanes/Lateral Shifts Neckdowns/Chokers Neighborhood Roundabouts

Chicanes/Lateral Shifts are curb extensions that alternate from one side of the roadway to the other, forming s-shaped curves. Neckdowns/chokers are curb extensions at intersections that reduce curb-to-curb roadway travel lane widths.

B. Traffic Calming Evaluation Procedure. The Commission or Council shall consider the following in determining whether a traffic calming measure should be installed.

1. Stop signs.

a. Installation of a stop sign may be warranted if an intersection meets at least one of the following criteria:

i) A visual obstruction is within 100 feet of the intersection and prevents a clear view of the intersection; obstructions may be removed to resolve the problem.

ii) The streets intersect at angles less than 80 degrees and/or have a slope of more than 5% within 100 feet of the intersection.

iii) The intersection experiences traffic flows in excess of 1,000 vehicles per day.

iv) A public school is within 660 feet of the intersection.

v) A public park or other public recreation area is within 660 feet of the intersections.

vi) A known history of accidents at the intersection.

b. The following criteria apply when placing a stop sign:

i) at intersections between an arterial and a collector or local street, traffic on the collector or local street is stopped.

ii) at intersections between two collector streets, traffic on both streets is stopped.

iii) at intersections between a collector and a local street, traffic on the local street is stopped.

2. All other traffic calming measures.

a. Installation of an acceptable traffic calming measure may be warranted if at least one of the following criteria is met:

i) 85th percentile speed is at least 10 mph over the posted speed limit.

ii) A petition is signed by at least 75 percent of the total occupied households within 300 feet from the proposed traffic calming measure(s).

18.06.022 Pedestrian Facility Design Guidelines and Standards.

A. Sidewalk Corridor. Sidewalk corridors should promote access and may include the following characteristics:

1. Clearly defined pedestrian, buffer/landscape/furniture, and frontage zones;
2. Wide pedestrian zones;
3. Minimal obstacles/protruding objects;
4. Minimal walking distance;
5. Moderate grades and cross slopes;
6. Rest areas outside of pedestrian zone;
7. Firm, stable, slip resistant surfaces; and
8. Adequate illumination, while still complying with the City's Outdoor

Lighting Ordinance.

B. Sidewalk Corridor Zones. The Sidewalk Corridor is divided into four distinct functional zones used to determine the width of the Sidewalk Corridor and help ensure that obstacles, such as utility poles and other street furniture, will not limit pedestrian access and mobility. Sidewalk Corridor zone widths are recommended in Section 18.06.014.

1. Curb (or Edge) Zone. The area between the face of curb and the furnishing zone providing clearance between parked vehicles or traveled way and appurtenances or landscaping.

2. Buffer/Landscape (or Furnishing) Zone. The area of the sidewalk corridor that provides a buffer between pedestrians and vehicles, which may contain landscaping, public street furniture, transit stops, art, bike racks, signage, or utilities.

3. Pedestrian (or Throughway) Zone. The area of the sidewalk corridor reserved for the movement of pedestrians. The pedestrian zone should be wide for two pedestrians to travel side by side without passing other pedestrians, or for two people going in opposite directions to pass one another.

4. Frontage (or Shy) Zone. The distance between the pedestrian zone and the building front or property line that is used to buffer pedestrians from window shoppers, appurtenances and doorways. The Frontage zone may contain art, signage, merchandise displays, or street furniture such as benches and café chairs and tables.

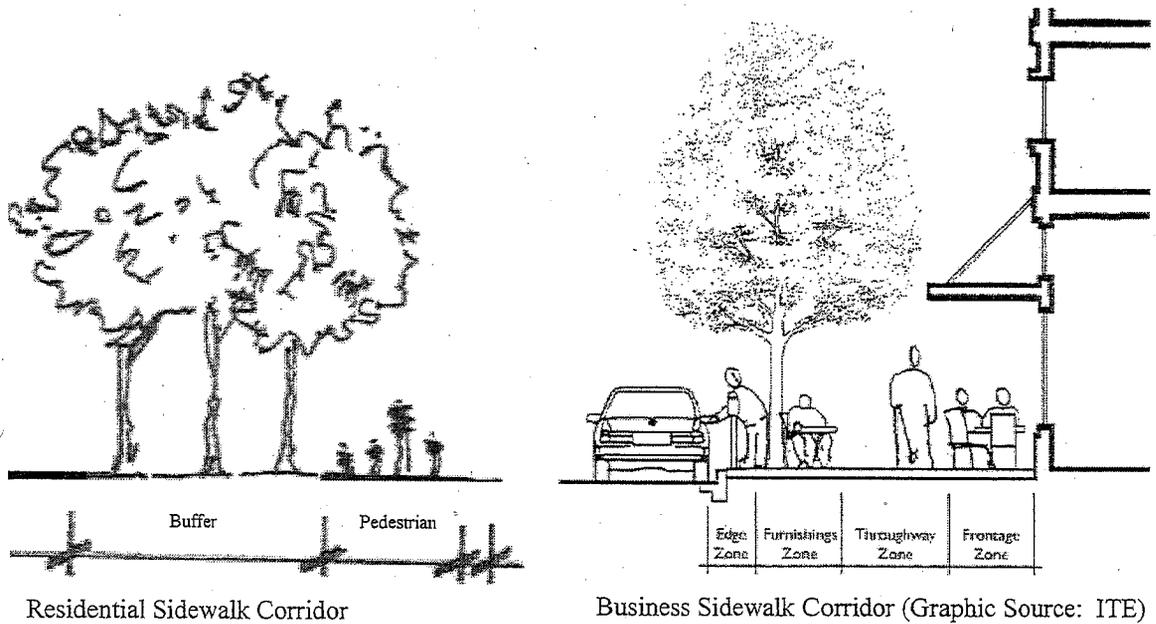

C. Sidewalk Corridor Clear Width, Grade and Cross Slopes. Minimum standards are based on American with Disabilities Act Accessible Guidelines (“ADAAG”).

1. Clear Width. A minimum clear width of 4 feet is required on all public and private sidewalks.

2. Sidewalk Corridor Grade Standards. The grade of the Pedestrian Zone shall not exceed the grade established for the adjacent roadway. Except the running slope of a pedestrian access route may be permitted to be steeper than the grade of the adjacent roadway, provided that the pedestrian access route is less than 1:20.

3. Sidewalk Corridor Cross Slope Standards.

- a. The cross slope of the Pedestrian Zone shall be 1:48 maximum.
- b. Changes in cross slope shall not exceed 2 percent.
- c. The number of driveway crossings should be minimized. When a driveway crossing is necessary the following types are acceptable:

- i) Level landing with return curb
- ii) Level crossing with parallel ramps
- iii) Level landing with jogged sidewalk

Driveway Crossing Types

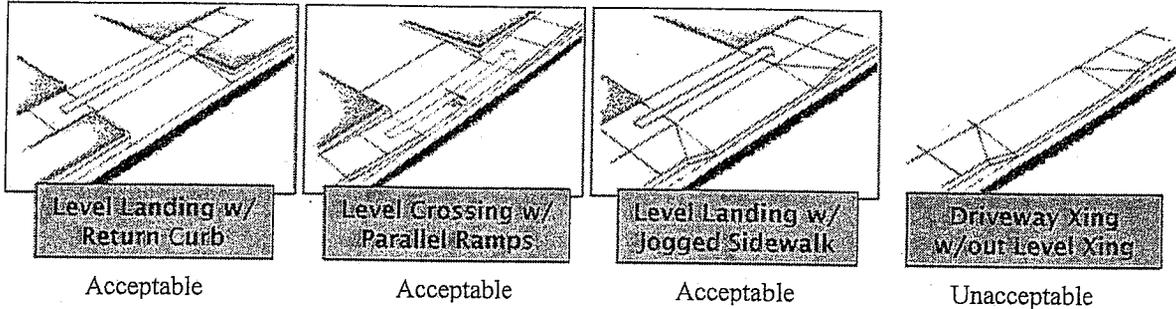

D. Curb Ramp Guidelines and Standards.

1. Best Practices. Curb ramp designs should attempt to meet all of the following Federal Highway Administration (“FHWA”) *Designing Sidewalks and Trails for Access* best practices for curb ramp design to maximize accessibility and safety for all pedestrians, particularly when retrofitting existing curb ramps:

- a. Provide a level maneuvering area or landing at the top of the curb ramp
- b. Clearly identify the boundary between the bottom of the curb ramp and the street with a detectable warning.
- c. Design ramp grades that are perpendicular to the curb.
- d. Place the curb ramp within the marked crosswalk area.
- e. Avoid changes of grade that exceed 11 percent over a 610 mm (24 in) interval.
- f. Design the ramp that doesn't require turning or maneuvering on the ramp surface.
- g. Provide a curb ramp grade that can be easily distinguished from surrounding terrain; otherwise, use detectable warnings.
- h. Design the ramp with a grade of 7.1, cannot exceed 8.3% (1:12).
- i. Design the ramp and gutter with a cross slope of 2.0 percent.
- j. Provide adequate drainage to prevent the accumulation of water or debris on or at the bottom of the ramp.
- k. Transitions from ramps to gutter and streets should be flush and free of elevation changes.
 - l. Align the curb ramp with the crosswalk, so there is a straight path of travel from the top of the ramp to the center of the roadway to the curb ramp on the other side. Provide clearly defined and easily identified edges or transitions on both sides of the ramp to contrast with sidewalk. Depending on site constraints, it may not be possible to incorporate all of the best practices within each curb ramp.

2. Curb Ramp Slope.

- a. For new construction curb ramp slope shall not exceed 8.3%.
- b. For retrofits where 8.3% ramp slopes cannot be attained, the following ADAAG exceptions may be permitted:

Maximum Rise	Minimum Slope	Maximum Slope
6 inches	8.3%	10%
3 inches	10%	12.5%

c. A slope steeper than 12.5% should be avoided regardless of length of ramp.

3. Ramp Cross Slope shall not exceed 2.0%.
4. Ramp Length – See FHWA Designing Sidewalks and Trails for Access.
5. Ramp minimum width is 4 feet (48 inches).
6. Drainage slopes shall not exceed 2%. The cross slope of the street and gutter approach shall not exceed 5%.
7. Transition areas shall have a gradual transition with a minimum grade change of less than 11%.
8. Sidewalk approaches shall have a minimum 3-foot (36 inch) clear space.
9. Slopes of a landing shall not exceed 2%. Landings should extend at least 4 feet beyond the top of the curb ramp for maneuverability (Fig. 1). If the space is limited and a 4-foot landing cannot be provided, an absolute minimum 3-foot (36 inch) landing is acceptable, provided the minimum ramp width is 4 feet (48 inches) and ramp flare slope does not exceed 8.3% (Fig. 2).

Curb Ramp Landings

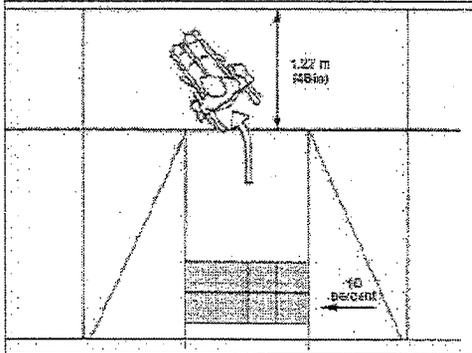

Fig. 1

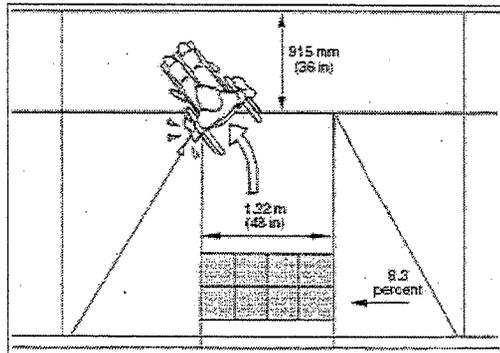

Fig. 2

E. Pedestrian Crossings.

1. Design Solutions at Wide Intersections. The following techniques are appropriate to use to improve pedestrian conditions and access at wide intersections, particularly on Main Street where appropriate right-of-way exists, and may be incorporated into a design:
 - a. Center medians to provide a refuge for slower pedestrians;
 - b. Accessible pedestrian signals to assist in providing people with vision impairments enough time to cross the street;
 - c. Increase crossing times so that people who walk slowly will have sufficient time to cross before the signal indication changes;

- d. Increase the crossing times so that people who delay the start of their crossing to confirm the WALK interval will have sufficient time to cross before the signal indication changes;
- e. Prohibit left turns during the .WALK interval;
- f. Restrict right turns on red;
- g. Enhance the visibility of the crosswalk markings or consider a raised crosswalk with detectable warnings (truncated domes) at both ends;
- h. Reduce crossing distances and increase visibility through the construction of curb extensions;
- i. Reduce traffic speed;
- j. Clarify the pedestrian crossing area by installing stamped or raised crosswalks with detectable warnings (truncated domes) installed at both ends;
- k. Pedestrian lead time and an accessible pedestrian signal so pedestrians, including those with vision impairments, can assert themselves in the crosswalk before motorists start making right and left turns;
 - 1. Mid-block signalized crossing with accessible pedestrian signal opportunities at busy intersections to encourage people to cross where there are fewer potential points of conflict between pedestrians and motorists;
 - m. Traffic and pedestrian signal indications if they do not already exist.

2. Turning Radius. Smaller turning radii are encouraged to slow traffic speeds, allow perpendicular curb ramps to be positioned parallel to the crosswalk and perpendicular to the curb, significantly decrease crossing distances for pedestrians, enhance detection of the crosswalk and improve crossing conditions for people with vision impairments. The addition of on-street bicycle lanes adds turning space for larger vehicles in lieu of wider curb radii.

3. Truncated Domes. Truncated domes shall be installed when altering curb ramps.

18.06.024 Bicycle Facility Design Guidelines and Standards

A. Sidewalks.

- 1. Sidewalks generally should not be considered bicycle facilities and should not be signed as a bicycle route.
- 2. Sidewalk riding by children or adults uncomfortable riding in the street is to be expected and tolerated, but should not be encouraged.

B. Shared-Use Path.

- 1. Shared-Use Paths are generally not recommended in areas within the City of Hailey served by the street network, but may be appropriate within an exclusive right-of-way, to connect neighborhood cul-de-sacs or where few, or no, driveways or street intersections will cross the path.
- 2. A Shared Use Path shall have a minimum pavement width of ten feet (10'), with a preferred width of 12 or 14 feet if significant volume and mix of users (pedestrians, cyclists, runners, skaters, etc.) or user types (children, basic adults, advanced riders) is present.

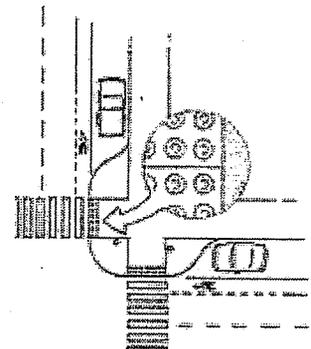

Truncated Domes

C. Bicycle Lanes.

1. Guidelines. Bicycle Lanes shall be one-way facilities and carry bike traffic in the same direction as adjacent motor vehicle traffic.

a. Two-way Bicycle Lanes on one side of the roadway are prohibited when they result in bicycles riding against the flow of motor vehicle traffic.

i) There may be special situations where a two-way Bicycle Lane for a short distance can eliminate the need for a bicyclist to make a double crossing of a busy street or travel on a sidewalk. This should only be considered after careful evaluation of the relative risks.

b. Bicycle Lanes on one-way streets are required to be placed on the right side of the street. Bicycle Lanes on the left side are unfamiliar and unexpected for most motorists but may be considered when a Bicycle Lane on the left will substantially decrease the number of conflicts, such as those caused by heavy bus traffic or unusually heavy turning movements to the right, or if there are a significant number of left-turning bicyclists.

c. Two-way Bicycle Lanes on the left side of a one-way street may be considered with a suitable separation from the motor vehicle traffic after a complete engineering study of other alternatives and relative risks.

2. Minimum Width.

a. For roadways with curb and gutter or where substantial truck traffic is present, or where motor vehicle speeds exceed 50 mph, the minimum width of a Bicycle Lane shall be 5 feet from the face of a curb or guardrail to the Bicycle Lane stripe. This 5-foot width should be sufficient in cases where a 1-2 foot wide concrete gutter pan exists, provided that a minimum of 3 feet of rideable surface is provided and the longitudinal joint between the gutter pan and pavement surface is smooth. The width of the gutter pan should not be included in the measurement of the rideable or usable surface. If the joint is not smooth, 4 feet of rideable surface should be provided.

b. If parking is permitted, the Bicycle Lane should be placed between the parking area and the travel lane and have a minimum width of 5 feet.

c. If parking is permitted but a parking stripe or stalls are not utilized, the shared area should be a minimum of 11 feet without a curb face and 12 feet adjacent to a curb face.

d. If the parking volume is substantial or turnover is high, an additional 1 to 2 feet of width is desirable.

e. For roadways with no curb and gutter, and where parking is prohibited and where the area beyond the paved shoulder can provide additional maneuvering width, the minimum width may be 4 feet.

3. Placement.

a. Bicycle Lanes between the parking lane and curb lane are prohibited.

b. On a street without curbs and gutters Bicycle Lanes should be located within the limits of the paved shoulder at the outside edge.

4. Pavement Surface.

a. The pavement surface in this area 32-40 inches from a curb face should be smooth and free of structures. Drain inlets and utility covers that extend into this area

may cause bicyclists to swerve and effectively reduce the usable width of the lane. Where these structures exist, the Bicycle Lane width may need to be adjusted accordingly.

5. Lane Striping.

a. A Bicycle Lane shall be delineated from the motor vehicle travel lanes with a minimum 6 inch wide solid white line.

b. An additional 4-inch solid white line may be placed between the parking lane and the Bicycle Lane. This second line will encourage parking closer to the curb, providing added separation from motor vehicles, and where parking is light it can discourage motorists from using the Bicycle Lane as a through travel lane.

6. Hazards.

a. Bicycle Lanes should be provided with adequate drainage to prevent ponding, washouts, debris accumulation and other potentially hazardous conditions.

b. Drainage grates should be bicycle-safe. When an immediate replacement of an incompatible grate is not possible, a temporary correction of welding thin metal straps across the grates perpendicular to the drainage slots at 4-inch center-to-center spacing should be considered.

c. A smooth riding surface should be provided and utility covers should be adjusted flush with the surface.

d. Raised pavement markings and raised barriers can cause steering difficulties for bicyclists and should not be used to delineate bicycle lanes.

7. Bicycle Lanes at Intersections.

a. Bicycle Lane striping should not be installed across any pedestrian crosswalks, and, in most cases, should not continue through any street intersections.

b. If there are no painted crosswalks, the Bicycle Lane striping should stop at the near side corner of the intersection and then resume at the far side corner. The only exception may be the extension of dotted guidelines through particularly complex intersections or multi-lane roundabouts.

c. The same Bicycle Lane striping criteria apply whether parking is permitted or prohibited in the vicinity of the intersection.

d. At signalized or stop-controlled intersections with right-turning motor vehicles, the solid striping to the approach should be replaced with a broken line. The length of the broken line section is usually 50 feet to 200 feet.

e. At non-signalized minor intersections with no stop controls and small volumes of right-turning motor vehicles, solid Bicycle Lane striping can continue all the way to the crosswalk on the near side of the intersection.

f. If there is a bus stop or high right-turn volume, the 6-inch solid line should be replaced with a broken line for the length of the bus stop. The Bicycle Lane striping should resume at the outside line of the crosswalk on the far side of the intersection.

g. If a bus stop is located on a far side of the intersection rather than on a near side approach, the solid white line can also be replaced with a broken line for a distance of at least 80 feet from the crosswalk on the far side of the intersection.

h. At T-intersections with no painted crosswalks, the Bicycle Lane striping on the side across from the T-intersection should continue through the intersection area with no break. If there are painted crosswalks, the Bicycle Lane striping on the side across from the T-intersection should be discontinued only at the crosswalks.

8. Bicycle Lanes and Turning Lanes. Bicycle Lanes sometimes complicate bicycle and motor vehicle turning movements at intersections. Because they encourage bicyclists to keep to the right and motorists to keep to the left, both operators are somewhat discouraged from merging in advance of turns. Thus, some bicyclists may begin left turns from the right-side Bicycle Lane and some motorists may begin right turns from the left of the Bicycle Lane. Both maneuvers are contrary to established rules of the road and may result in conflicts; however, these can be lessened by signing and striping.

a. At intersections, bicyclists proceeding straight through and motorists turning right must cross paths. Striping and signing configurations which encourage crossings in advance of the intersection, in a merging fashion, are preferable to those that force the crossing in the immediate vicinity of the intersection. To a lesser extent, the same is true for left-turning bicyclists; however, in this maneuver, most vehicle codes allow the bicyclist the option of making either a “vehicular style” left turn (where the bicyclist merges leftward to the same lane used for motor vehicle left turns) or a “pedestrian style” left turn (where the bicyclist proceeds straight through the intersection, turns left at the far side, then proceeds across the intersection again on the cross street) (Figure 17).

b. Where there are numerous left-turning bicyclists, a separate turning lane can also be considered. The design of Bicycle Lanes should also include appropriate signing at intersections to warn of conflicts. General guidance for pavement marking of Bicycle Lanes is contained in the MUTCD 2. The approach shoulder width should be provided through the intersection, where feasible, to accommodate right-turning bicyclists or bicyclists who prefer to use crosswalks to negotiate the intersection.

c. Intersections with throat widening at approaches that provide an exclusive left-turn bay can also provide an exclusive right-turn lane for motor vehicles. In those cases where throat widening has reduced the available pavement width below the minimum requirements for Bicycle Lane operation and it is not possible to widen the pavement, the Bicycle Lane striping should be discontinued following a regulatory sign. Bicyclists proceeding straight through the intersection should be directed to merge with motor vehicle traffic to cross the intersection. Where sufficient width exists, a separate through Bicycle Lane should be placed to the right of the through lane.

9. Bicycle Lane Symbols and Markings.

a. Pavement markings and signing guidance provided by the Manual of Uniform Traffic Control Devices (MUTCD) shall be followed when striping bicycle lanes.

D. Bicycle Racks.

1. A single bicycle rack shall meet the following criteria:

a. Support the bicycle upright by its frame in two places.

b. Prevent the wheels of the bicycle from tilting or twisting.

c. A U-lock should be able to lock the front wheel and the down tube of an upright bicycle or lock the rear wheel and seat tube of the bicycle.

2. Two or more single racks may be mounted in a row on a common base or attached in a row to a frame.

3. Inverted "U" racks mounted in a row should be placed 30 inches apart on center, allowing enough room for two bicycles to be secured to each rack and providing easy access to each bicycle.

4. Racks should be made of material that resists being cut or detached using common hand tools. The rack should be anchored so that it cannot be stolen with the bikes attached. Racks that are large and heavy enough such that the rack cannot be easily moved or lifted with the bicycles attached do not have to be anchored.

5. Racks shall be placed so that they do not block the entrance, inhibit pedestrian flow in or out of the building or generally impede snow removal. If placed on a sidewalk, racks should be placed so that at least 5 feet of sidewalk width is maintained.

6. Where multiple racks are installed in rows with aisles separating the rows the following dimensions shall apply:

a. Minimum aisles width shall be 48 inches. The aisle is measured from tip to tip of bike tires across the space between racks.

b. Minimum depth shall be 72 inches for each row of parked bicycles.

c. Areas with a high turnover rate should have a minimum aisle width of 72 in and should have more than one entrance.

7. Racks shall be mounted within 50 feet of the entrance it serves, or as close as the nearest car parking space, whichever is closer and shall be clearly visible from the entrance it serves.

Supports frame in two places:

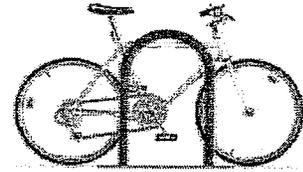

Appropriate designs:

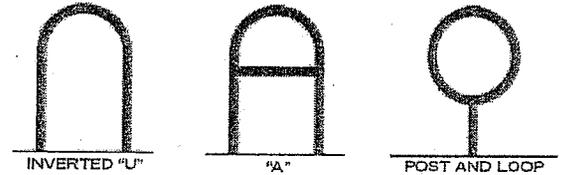

Inappropriate designs:

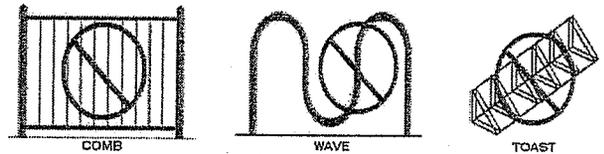

Adequate spacing between racks:

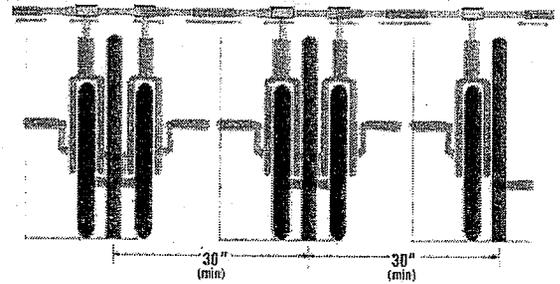

Bicycle racks at building entrances:

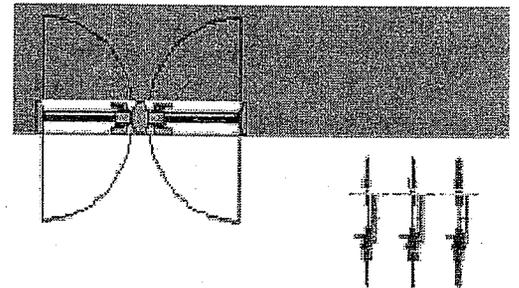

Adequate spacing between rows of racks:

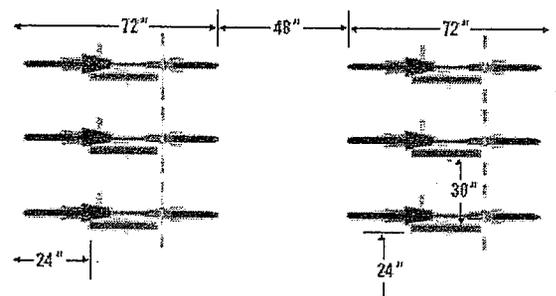

8. Creative, three-dimensional bicycle-racks are permitted provided the criteria of the rack design are met.

9. When possible, bicycle parking areas should be protected from the elements (rain, snow, etc.).

18.06.026 Street Tree Guidelines and Standards.

A. The selection of species and the placement of trees within a Sidewalk Corridor Zone requires an encroachment permit and review the Hailey Tree Committee to ensure the following guidelines are met:

1. Species Selection.

a. Species that sucker or drop significant amounts of fruit or seeds or pods that may cause liability/safety issues are prohibited.

b. Species should tolerate environmental stressors such as pollution, unreasonable growth space, pruning and people. The proximity of sign, utilities, automobiles and other space constraints and conflicts should also be considered.

c. Species selected shall be within the USDA hardiness zones 4-6.

2. Caliper.

a. Minimum caliper two-inch

b. Maximum caliper four-inch, except as recommended by the Hailey

Tree Committee.

3. Spacing.

a. Trees shall be spaced to maximize the ability of the species selected to thrive over time.

18.06.028 Streetscape Elements Guidelines and Standards.

A. Street Lights. Street Lights are required to be installed at intersections on Business/Collector Streets and should maximize the lighting of the Pedestrian Zone and crosswalks.

B. Tree Grates. Tree Grates are required for street trees planted on Business/Collector streets.

C. Trash and Recycling Receptacles. The standard trash receptacle is "Central Park" receptacle. Recycling receptacles are also encouraged.

D. Benches. A variety of styles with similar elements are encouraged to add interest to the streetscape and avoid monotony.

E. Drinking Fountain. Opportunities to incorporate drinking fountains into key public spaces should be considered.

F. Public Art. The incorporation of public art is encouraged. Any streetscape element can take the form of public art.

Benches, Tree Grates and Trash Receptacles as Art

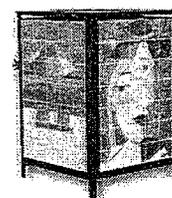

Landscape Forms
Gretchen

Plainwell

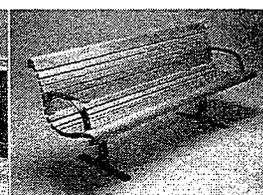
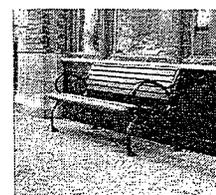

Chapter 18.07

Transit Stop Standards

Reserved

Chapter 18.08

Street and Drainage Construction

Street and Drainage Construction

Sections:

- 18.08.009 Street and Drainage Construction
- 18.08.010 Sub-Grade Preparation
- 18.08.012 Two Inch Sub-Base Course
- 18.08.014 3/4 Inch Crushed Aggregate Base Course
- 18.08.016 Plant Mix Pavement
- 18.08.018 Concrete and Reinforced Concrete
- 18.08.020 Standard Concrete Curb and Gutter
- 18.08.022 Concrete Valley Gutter
- 18.08.026 Concrete Catch Basins
- 18.08.028 Concrete Sidewalk
- 18.08.030 Drywell
- 18.08.032 Seal Coat
- 18.08.034 Silt Fences

18.08.009 Street and Drainage Construction

A. All street and drainage construction shall be in accordance with these Hailey Standard Specifications, the Hailey Standard Drawings, and the current edition of the Idaho Standards for Public Works Construction (ISPWC)

18.08.010 Sub-Grade Preparation

A. General

1. The Contractor shall do all excavation, stripping, disposal, and compaction of subgrade necessary within the street right-of-way. The work shall include the removal and disposal of any minor structures or miscellaneous obstructions, which are visible or are indicated on the Plans, which encroach upon or otherwise obstruct the work. All unsuitable material such as rocks, and rubbish shall be disposed of by the Contractor at an approved disposal area.

B. Execution

1. The top twelve (12) inches of subgrade shall be compacted to a minimum of ninety- five percent (95%) of the maximum density as determined by ASTM D698. Only subgrade material approved by the City Engineer or his representative may be used. All soft spots or otherwise unsuitable material shall be removed and replaced with suitable material. The subgrade shall be watered or aerated as necessary to obtain optimum moisture content as determined by ASTM D698. Subgrade shall be finished to within 0.10 feet of the grade and cross sections shown on the plans or as staked on the ground. Compaction equipment shall be of the size and type capable of obtaining specified compaction. Compaction equipment shall be approved by the City Engineer.

2. At all times, the top of the subgrade shall be kept in such condition that it will drain readily and effectively. In no case will vehicles be allowed to travel in a single track. If ruts are formed, the subgrade shall be reshaped and recompact to the required density. Storage or stockpiling of materials on the top of the subgrade will not be permitted. Until the subgrade has been inspected and approved no sub-base, leveling course, or pavement shall be placed thereon.

3. Embankments required to construct the subgrade shall be compacted to a minimum of 95% of the maximum density as determined by ASTM D698. Embankment material shall be approved by the City Engineer. Embankment material may be from onsite borrow areas or imported from offsite borrow areas as approved by the City Engineer. Embankment shall be placed in layers not exceeding eight (8) inches in loose thickness. Each layer shall be uniformly compacted at $\pm 3\%$ of the approved optimum moisture content to a minimum of 95% of the maximum density as determined by ASTM D698. A copy of the soil inspection report from a certified inspector for this requirement shall be provided to the City Engineer. A minimum of one test per 250 feet of street shall be performed. Compaction tests shall be performed at the Contractor/Developer's expense. Watering or aeration as necessary shall be accomplished to obtain optimum moisture content. Compaction equipment shall be of the size and type capable of obtaining specified compaction. Where embankments are to be placed on slopes steeper than three to one, horizontal benches shall be constructed. In the construction of embankments, starting layers shall be placed in the deepest portion of the fill; as placement progresses, layers shall be constructed approximately parallel to the finished grade line. If pipelines are to be placed in the embankment, the embankment shall be constructed to an elevation of two feet above the top of the pipe prior to trench excavation for the pipeline. Completed embankments shall be dressed to elevations and slopes specified on the plans or as staked by the Engineer.

18.08.012 Two Inch Sub-Base Course

A. General

1. The Contractor shall furnish and place on the prepared subgrade one (1) or more courses of approved two (2) inch minus gravel in conformity with the City of Hailey Standard Drawings and Standard Specifications, and to the lines and grades established.

B. Material

1. The aggregate used for the Sub-Base course shall be Type II Crushed Aggregate per the current edition of the Idaho Standards for Public Works Construction-Section 802-Crushed Aggregates

2. The Contractor shall use crushed aggregate conforming to the following gradations:

PERCENTAGE BY WEIGHT PASSING SIEVE

Sieve Size Percentage

2 1/2 Inch 100

2 Inch 90-100

1 Inch	55-83
No. 4	30 - 60
No. 30	10 - 25
No. 200	0-8

3. Pit run gravel may be substituted for the two (2) inch gravel base course with prior approval by the City Engineer. The pit run gravel shall consist of six-inch minus, well-graded, pit-run gravel with no more than 12% passing through the No. 200 sieve that is in accordance with the current edition of the Idaho Standards for Public Works Construction-Section 801 Uncrushed Aggregates. Pit-run gravel shall be obtained from designated or approved sources; it shall be clean and free from roots or organic material.

C. Execution

1. The aggregate, as spread, shall be of uniform gradation with no segregation or pockets of fine or coarse materials. Material shall not be placed in snow or on a soft, muddy, or frozen underlying course.

2. After conditioning and spreading, the aggregates shall be thoroughly compacted by rolling for its full width. The rolling shall continue until the stone is thoroughly set and until creeping of the stone ahead of the roller is no longer visible. Compaction shall continue until not less than 95% of the maximum density, as determined by ASTM D698 is obtained. Compaction tests will be performed as deemed necessary by the City Engineer, at the Owner/Developer's expense.

3. In areas inaccessible to rollers, the aggregate material shall be compacted by mechanical methods.

4. The surface of each layer shall be watered during compaction in operations in such a manner that a uniform texture is produced and the aggregate firmly keyed. Water shall be uniformly applied at $\pm 3\%$ of the approved optimum moisture content over the materials during compaction in the amount necessary for proper consolidation to obtain a field density. When in the opinion of the City Engineer, the weather is such that satisfactory results cannot be secured, the Contractor shall suspend operations until the weather is favorable.

5. After the work is complete, the entire area shall be neatly finished and trimmed to the lines, grades, and cross sections. All material shall be removed and stockpile areas shall be cleared of all aggregate and left in an acceptable condition. Until the sub-base has been inspected and approved no base course or plantmix pavement shall be placed thereon.

6. The Contractor has the option of substituting three-quarter (3/4) inch minus Type I Pipe Bedding per the current edition of the Idaho Standards for Public Works Construction-Section 802-Crushed Aggregates

18.08.014 3/4 Inch Crushed Aggregate Base Course

A. General

1. The Contractor shall furnish and place on the prepared sub-base course a course of three-quarter (3/4) inch minus crushed aggregate that conforms to Type I Pipe Bedding per the current edition of the Idaho Standards for Public Works Construction-Section 305-Pipe Bedding in conformity with the Plans and in accordance to the City of Hailey Standard Drawings and these Standard Specifications to the lines and grades established by the Approved Construction Plans.

B Materials

1. The Contractor shall use crushed aggregate conforming to Crushed Aggregate for Base Gradations per the current edition of the Idaho Standards for Public Works Construction-Section 802-Crushed Aggregates with the following gradations:

PERCENTAGE BY WEIGHT PASSING SIEVES

<u>Sieve Size</u>	<u>Percentage</u>
1 Inch	100
3/4 Inch	90 - 100
No. 4	40 - 65
No. 8	30 - 50
No. 200	3 - 9

C. Execution

1. The 3/4" Crushed Aggregate Base Course shall be compacted to a minimum of ninety-five percent (95%) of the maximum density as determined by ASTM D698.

2. All curb and gutter shall be placed and the fill behind the curb and gutter backfilled in accordance with Section 18.08.020 prior to placing the base course.

3. The 3/4" Crushed Aggregate Base Course shall be conditioned, spread, and compacted in accordance with the requirements of Section 18.08.012 of these Standard Specifications. The base course shall be inspected and approved by the City Engineer prior to placement of the plantmix pavement.

18.08.016 Plant Mix Pavement

A. General

1. This item consists of placing asphalt plant mix surfacing and tack coat in accordance with these Specifications and the lines and grades established.

B. Materials

1. The grade of asphalt cement to be used shall be PG 58-28 (Performance Grade). The asphalt cement used shall comply with and be in accordance with Sub-section 702.01 of the (2004) State of Idaho, Transportation Department, Division of Highways, Standard Specifications for Highway Construction, and most recent Supplemental Specifications thereto. The liquid asphalt content shall be 5.0 % to 7.0 %, by weight, of the combined dry aggregate. The exact percentage of asphalt in the mix shall be fixed by the Engineer based upon preliminary laboratory tests, sieve analysis, grading and character of the aggregate furnished within the

specification limits. The City of Hailey will reject any batch or load of resultant mixture that contains an excess or deficient amount of asphalt varying more than four-tenths (0.4) of one (1.0) percent from the exact percentages as fixed by the Engineer. The upper limit may be increased if absorptive aggregates are used. The Owner/Developer will submit certifications to the City Engineer, if requested, certifying the conformance of the asphalt material.

2. The mineral aggregate shall meet the following gradation requirements unless otherwise accepted by the Engineer: The ENGINEER shall provide a current sieve analysis of the proposed aggregate to the CITY ENGINEER.

<u>Passing sieve size</u>	<u>% By Weight Passing Square Mesh Sieve</u>
1/2 Inch	95-100
3/8 Inch	75-90
No. 4	50-75
No. 8	35-60
No. 30	15-35
No. 50	10-25
No. 200	4-8
Sand Equivalent	not less than 35

a. The aggregate shall show a loss of not more than 35% on the Los Angeles Abrasion Test.

b. The above gradations represent the extreme limits, which shall determine the suitability of aggregate for use. The final gradation as approved by the Engineer shall not vary from the low limits on one screen to the high limits on the adjacent screen, or vice-versa.

3. The job-mix formula shall be designated in accordance with HVEEM Method of Testing Asphalt Mixtures for Relative Stability AASHTO T-246 and T-247, and shall have the following in-place criteria:

- a. Minimum Stability = 35
- b. Minimum Film Thickness = 6 micron.
- c. Percent Air Voids = 3-5%
- d. Minimum Immersion Compression = 85%.
- e. Percent Voids in Mineral Aggregate, Minimum=13%

4. The Contractor shall be responsible for providing information concerning the need for anti-stripping additive as determined by an independent laboratory using AASHTO test methods T165 and T182, latest editions. The Engineer shall provide a job mix formula to the City Engineer. The Owner/Developer shall arrange for an independent laboratory test at his own expense.

5. A tack coat shall be applied to all surfaces that will be in contact with the new asphalt pavement. The tack coat shall be liquid asphalt grade CSS-1 and shall conform to the Specifications Series No.2 (CSS-1) of the Asphalt Institute. The rate of application shall be .05 to .10 gallons per square yard.

C. Workmanship

1. Plant Mix Placement

a. The plant mix surfacing shall be placed over the prepared or tacked surface. Placement shall be accomplished with a self propelled paver with an automatic screed operable from a profile "shoe" or "ski" referencing the base surface or adjoining completed surface. The length and type of the shoe or ski shall be acceptable to the City Engineer and capable of compensating for minor variations in the base profile. The minimum ambient temperature for laying plant mix pavement shall be 40°F and rising. The laydown temperature shall be 270° to 310°F or as specified on the mix formula sheet from a certified laboratory testing firm.

2. Connections with Existing Surfacing

a. Connections to existing surfacing shall be accomplished by cutting back the existing surface to a vertical face to assure positive full depth paving. The vertical face shall be tacked with CSS-1 prior to paving.

3. Rolling

a. Unless otherwise directed, the initial or breakdown rolling shall consist of one complete coverage of the paving mixture performed with a two-axle tandem roller and shall weigh 7 to 13 tons. Rolling shall be performed in such a manner that cracking, shoving, or displacement will be avoided. Any surface cracks shall be seal coated by applying an emulsion. Final rolling shall be completed the same day the pavement is placed.

b. Any displacement occurring as a result of the reversing of the direction of a roller or from other causes shall be corrected at once by the use of rakes and addition of fresh mixture when required. Care shall be exercised in rolling not to displace the line and grade of the edges of the pavement. Rolling shall continue until all roller marks are eliminated, the surface is of uniform texture, and true to grade and cross section.

c. To prevent adhesion of the mixture to the rollers, the wheels shall be kept properly moistened with water or water mixed with very small quantities of detergent or other approved material. Excess liquid will not be permitted.

d. Along all edges, forms, curbs, headers, walls, and other places not accessible to the rollers, the mixture shall be thoroughly compacted with hot hand tampers, smoothing irons, or with mechanical tampers.

e. The Contractor shall compact the mix to a density of at least ninety-five percent (95%) of maximum density as based on the HVEEM Method. The pavement thickness shall be a minimum of three (3) inches after rolling.

4. Shoulders:

a. When the rolling of the surface course has been completed and the edges have been thoroughly compacted, gravel shoulder material shall be placed against the edges and rolled.

5. Surface Smoothness

a. The completed surface shall be uniform and to proper line and profile. The completed surfacing shall not vary more than 1/4 inch from a ten-foot straight edge

centerline. Slope shall be controlled and in accordance with the plan typical section. Test for conformity shall be made immediately after initial compaction and variations shall be corrected by removing or adding materials as may be necessary. Rolling shall then continue as specified. After final rolling, the smoothness of the course shall be checked again and any irregularity of the surface exceeding the above limits and any area defective in texture, compression, or composition shall be corrected, including removal and replacement of unsatisfactory material, as directed by the City Engineer.

6. Weather Limitations

a. Plant mix material shall not be placed on a wet surface; when the air temperature is below 40°F; or when weather or surface conditions otherwise prevent the proper handling or finishing of the plantmix material.

7. Quality Control

a. The Contractor shall notify the City a minimum of 24 hours prior to beginning any work covered by this section.

b. Samples may be taken each day of production. Testing and frequency may be reduced by the City Engineer if test results and visual observations indicate consistent mix production.

c. Core samples may be required by the City Engineer to verify mix samples or air void content. Cores will not normally be required if asphalt content and gradation test results remain within acceptable tolerances.

d. Sampling and testing methods shall be approved in advance by the City Engineer. Copies of all test reports shall be submitted to the City Engineer.

8. Penetration

a. All manhole lids, water valve boxes, drywell lids, and other items which must penetrate the pavement shall be installed and covered, as appropriate, below the surface of the leveling course prior to paving. The contractor shall extend these items through the pavement and install a concrete collar after paving is complete. The contractor shall accurately locate these items to assure a minimum amount of disturbance occurs.

D. Guarantee

a. The Owner/Developer shall be responsible for any damage or failure, progressive or total, of the plantmix surfacing for the period of two years following completion of the construction. This shall include any deformation of the roadway cross-section or profile.

b. Replacement or repair of the unsatisfactory areas shall be as specified by the City Engineer. The completion of the repairs, as specified, will satisfy the requirements of the GUARANTEE.

18.08.018 Concrete and Reinforced Concrete

A. General

1. This section covers the work necessary for the concrete and reinforced concrete, including but not limited to furnishing the materials, constructing and stripping the forms; proportioning, mixing, transporting, placing, compacting, finishing, curing and protecting the concrete; furnishing and installing reinforcing steel; setting and fastening embedded items; and all incidental and related work.

B. Material

1. Strength
 - a. All concrete 28-day compressive strength, unless otherwise specified, shall be 3000 psi.
2. Concrete Mixture
 - a. Cement: Only Portland cement conforming to ASTM Specification C-150, Type I, Normal, or Type III, High Early Strength, shall be used unless otherwise specified. There shall be a minimum of 517 pounds of cement per yard of concrete.
 - b. Aggregates: Concrete aggregates shall conform to ASTM Specification C-33 for Concrete Aggregates or for the applicable sections of the specifications for Highway Construction. The maximum size of coarse aggregate shall be one inch unless specified otherwise. No aggregate shall contain organic matter in excess of that permitted by ASTM C-40.
 - c. Water: Mixing and curing water shall be clean, free from deleterious amounts of acids, alkalis, soils, decayed vegetable matter, or other organic materials. In general, water suitable for drinking will be considered acceptable but will be subject to review by the Engineer.
 - d. Admixtures: Only air-entraining admixtures will be used unless otherwise specifically authorized in writing by the City Engineer. The admixtures used for air entrainment shall conform to ASTM Specification C-260 and the specific brand used and method of introduction into the mix shall be subject to review by the City Engineer.
3. Forms
 - a. Forms shall be of wood, metal or of such other material as approved by the City Engineer.
4. Reinforcing Steel
 - a. All reinforcing rods for concrete reservoirs shall conform to ASTM Specification A-615, grade 60. Other reinforcing rods shall conform to ASTM Specification A-15 or A-16. All reinforcing rods shall have deformations conforming to ASTM Specification A-305. Welded wire fabric shall conform to ASTM Specification A-185.
5. Fibermesh
 - a. Fibermesh shall be added to all concrete placed in the City of Hailey. All fibermesh shall meet ASTM Standard C1116.
6. Waterstops
 - a. Polyvinyl chloride, minimum 1750 psi tensile strength, maximum possible lengths, preformed corners, heat welded splicing.
7. Nailing Strips
 - a. Pressure treated Douglas Fir.
8. Curing Compounds
 - a. Type 2, Class A per ASTM C 309-94

C. Execution

1. Formwork
 - a. General: Forms shall be accurately built and placed to conform to the shape, line, grade and dimensions of the concrete called for on the Plans. Material previously used in forms shall be thoroughly cleaned and free of nails before being reused if in contact with concrete. Forms shall be mortar tight. All concrete angles shall be beveled or filleted unless otherwise specifically shown on the plans or authorized by the City Engineer. Bevels and fillets

shall be approximately 3/4 inch in dimension and (except where specifically detailed otherwise on the Plans) shall all be of the same size. Discontinuous edges of horizontal surfaces may be rounded with an edging tool.

b. Design and Construction: Form work shall be designed to properly support all loads which may fall upon it during the placing and compaction of concrete and that portion of the curing period during which the concrete is unable to support itself. If the form should shift or be damaged during or subsequent to the placing of concrete in a surface which will be exposed to view during the service of the finished structure such disfigurement shall be removed and/or corrected to the practical intent of the Plans. Where plywood is used as form liner, adjacent pieces of plywood shall have the grain running parallel with each other if in doing otherwise the structure would be disfigured. In any case, all wood shall be treated with non-staining form oil or by other means in order to prevent raising the grain when the surface becomes wet. On interior circular walls, tongue and groove lumber or lumber lined with plywood shall be used. Where surfaces are to be given a special finish, which is not affected by the forms, one-inch boards of uniform width may be used for forms. All joints between adjacent pieces of form lumber shall be closely fitted to prevent disagreeable lines in the concrete and to prevent the loss of mortar from the concrete mix with the consequent formation of rock pockets in the concrete.

i) Manner and type of form tying shall be subject to the review of the City Engineer. Of primary concern in this respect is the effect on the finished appearance of the structure produced by the use of the particular tie under consideration. The City Engineer may require a change in the method of tying forms at any time if it is reasonable that the results being produced by the method in use are detrimental to the appearance of the structure and a more satisfactory result can be obtained through the use of a different method. In general, the use of twisted wire for form ties will not be permitted. Ties for walls exposed to weather or earth shall have the conical or spherical type heads and shall be so constructed such that when the forms are removed no metal shall be within 5/8 inch of any surface. Diesel fuel shall not be used for form treatment.

ii) The use of reusable form work provided by companies specializing in the manufacture and rental of such units will be permitted providing the forms meet the aforementioned requirements, especially those regarding mortar tight joints.

iii) No form treatment shall be applied in such a manner that it will contaminate the reinforcing steel or impair the bond of concrete with it. When oiling forms, care shall be taken in those areas where subsequent work must be bonded to the concrete and no form treatment shall be used which might impair this bond. Diesel fuel shall not be used for form treatment.

c. Removal of Forms: Forms shall be removed after the concrete has gained sufficient strength to resist damage during the process of removal. Consideration shall be given to the loads on the concrete, the dead load of the concrete itself, the weather and other conditions affecting the curing of the mix and the mix itself in determining the length of time to elapse between the placing of concrete in the forms and the removal of the forms.

i) In general, the following periods, exclusive of days when the temperature falls below 40° F, may be used as a guide for the removal of formwork subject to the approval of the Engineer.

<u>Description</u>	<u>Time Period</u>

Walls	12 to 24 hours
Sides of beams and other parts	12 to 24 hours
Columns	1 to 7 days
Suspended slabs and beam centering	7 to 14 days

2. Concrete Reinforcement

a. General: The Contractor shall furnish and place all steel reinforcement including rods, welded wire fabric, and structural shapes as indicated on the Drawings or otherwise required. At the time of concrete placement all reinforcing shall be free from loose, flaky rust and scale, oil, grease or any other coating, which might destroy or reduce its bond with the concrete. All placing shall be done in accordance with Drawings furnished by the Contractor and reviewed by the City Engineer.

b. Fabrication: In general, detail in fabrication shall follow the Manual of Standard Practice for Detailing Reinforcing Concrete Structures by the American Concrete Institute. The Plans show amounts and placement of reinforcing necessary for the structure, but some deviation from the Plans will be permitted, subject to review by the City Engineer, if the same bar area and perimeter of steel is present in all concrete sections.

i) Reinforcement shall be accurately formed to the dimensions indicated on the Plans and the bending details. All bars shall be bent cold. No bending or straightening shall be done in any manner that will injure the material. Where splicing of reinforcement is permitted, not less than 24 bar diameters shall be overlapped unless otherwise provided by the Plans or elsewhere in the Specifications. The minimum overlap for lapped splices in flat slab construction shall not be less than 36 bar diameters. Where special splice details are shown on the Plans they shall be strictly followed.

c. Placing: The steel shall be placed in position accurately as shown on the Plans or Supplemental Drawings. The steel shall be secured so that no displacement shall occur during the placing and compacting of the concrete. The Plans do not show all required tie bars nor do they show chairs or any other locating devices except in special instances. The fabricator shall take note of this and shall provide these extra bars and appliances necessary to accurately hold the reinforcing steel in the positions indicated. After reinforcement is placed and at least 24 hours before concrete is to be poured, the placement of the reinforcement and anchor bolts must be inspected and approved by the City Engineer.

i) Galvanized metal chairs shall be used to support reinforcing in slabs where the slab undersurface will be exposed for ceilings or overhangs. Splices in bars shall be staggered where possible. Where welded wire fabric is lapped, the lap shall not be less than one mesh interval in width. When the steel is placed, it shall be free from dirt, detrimental rust, loose scale, paint or any other foreign material. The bars shall be tied at all intersections except where spacing is less than one foot in each direction in which case alternate intersections may be tied. If welding is required, the above-mentioned requirements shall be

supplemented by the requirements of ASWD 12.1, Recommended Practices for Welding Reinforcing Steel, Metal Inserts, and Connections in Reinforced Concrete Construction.

ii) Reinforcement in concrete placed against earth without forming shall have no less than three inches of concrete between it and the ground contact surface. Reinforcing in concrete exposed to the weather, or to be in contact with the ground following the removal of forms, shall be protected with not less than two inches of concrete for bars larger than No.5, and 1 1/2 inches for No.5 and smaller bars. Reinforcement in concrete surfaces not exposed directly to the ground or to the weather shall have not less than 3/4 inch of concrete between the reinforcing steel and the surface for slabs and walls and not less than 1 1/2 inches for beams and girders. Concrete joist floors in which the clear distance between joists is not more than 30 inches, the protection of the reinforcement shall be at least 3/4 inch. Columns shall have at least 1 1/2 inches of concrete outside the column ties or spiral reinforcing.

iii) The minimum clear distance between parallel bars shall not be less than one inch or less than 1 1/3 times the maximum size of the coarse aggregate.

iv) Where necessary to cut bars for openings and where not shown otherwise, an equivalent area of steel shall be placed around the opening and extended on each side sufficiently to develop bond in each bar.

3. Embedded Items

a. General: Cooperation and coordination with all other Contractors and/or Subcontractors and all trades shall be made in order that all inserts and fastening devices such as anchors, hangers, ties, bolts, conduits, blockouts, waterstops, seep rings, nailing strips or any other embedded item shall be properly located and secured in position before concrete is placed.

b. Waterstops: Intersection pieces shall be furnished to form a continuous seal. Splices shall be made using thermostatically controlled heating elements in strict accordance with the manufacturer's instructions. The strength of the splice shall be at least 50% of the strength of the base material.

c. Nailing Strips: Nailing strips shall be of a size and shape indicated on the Plans and shall be of Douglas Fir, pressure treated after cutting to size. The type of pressure treatment shall be subject to the Engineer's review.

d. Hatches, Manholes and Other Openings: Openings in the concrete structure shall be as detailed on the Drawings or as reviewed by the City Engineer. Where it is necessary to cut steel that would otherwise extend through the opening, the equivalent amount shall be placed in the slab on each side of the opening. Where openings are edged with metal inserts or are formed by the metal inserts themselves, the reinforcing displaced by such opening outlines or edgings shall be moved to the edges of the openings and extended beyond the edge of the opening at least thirty bar diameters in each direction and located and secured in a position and in a manner satisfactory to the City Engineer unless otherwise defined in the Plans.

4. Placing Concrete

a. Proportioning: The proportions of water, sand, cement, fine and coarse aggregate and air entraining agent shall be so determined and fixed as to produce concrete having the strength and properties specified. Mixes shall be designated or verified by independent testing laboratories approved by the City Engineer at the Owner/Developer's expense. Air content in all concrete shall be held between three percent and five percent for mixing and handling. The water-cement ratio shall not exceed six U.S. gallons per bag (94

pounds) of cement. Concrete to be placed under water shall have the cement content increased ten percent above that normally used for the strength concrete required. If a change in the proportions of the concrete mix is necessary to meet changed conditions on the job or to more adequately meet the requirements of particular portions of the structure being assembled, such changes shall be promptly complied with.

b. Mixing: All concrete shall be machine mixed. All concrete placed in pours of 0.5 cubic yard or more shall be ready mix concrete, unless otherwise approved by the City Engineer. Ready mix concrete shall be batched and handled by plant and equipment conforming to ASTM Specification C-94. The maximum size of batch in truck mixers shall not exceed the maximum rated capacity of the mixer as stated by the manufacturer and stamped in metal on the mixer. Concrete transported in a truck-agitator or other transportation device shall be discharged at the job and placed in its final position in the forms within one and one-half hours after introduction of the mixing water to the cement and after introduction of the mixing water to the cement and aggregate, except that in hot weather or under other conditions contributing to quick stiffening of the mix, the maximum allowable time may be reduced by the City Engineer.

i) Concrete shall be mixed only in such quantities as is required for immediate use and any that has begun to develop initial set shall not be used. Concrete, which has partially hardened, shall not be retempered or remixed, nor shall materials be batched into a truck partially filled with concrete that was earlier batched.

c. Placing: Water shall be removed from the space to be occupied by the concrete before it is deposited unless otherwise directed by the City Engineer. Concrete shall be placed to avoid segregation of the materials and the displacement or movement of the reinforcement. The use of long troughs, chutes, and pipes for conveying concrete from the mixer to the form will be permitted only on written authorization of the City Engineer. In case an inferior quality of concrete is produced by the use of such conveyors, the City Engineer may order discontinuance of their use and the substitution of a satisfactory method of placing. Open troughs and chutes shall be metal or metal lined, approximately semi-circular in cross section and kept clean and free from coatings of hardened concrete by scraping and/or thoroughly flushing with water after each run. The water used for flushing shall be discharged clear of the structure in such a manner as not to contaminate concrete in the forms. Free drop of the concrete mix from chutes shall not be more than four feet. If greater fall is entailed in placing concrete to its final position, drop chutes or elephant trunks shall be used. In walls or other situations where the placing of concrete requires placing the mix through a net of reinforcing steel, if the free drop exceeds three feet, drop chutes or elephant trunks shall be used.

i) In high or thin walls, or where concentration of reinforcing steel occurs, openings shall be provided in the forms in order to facilitate placement of concrete without segregation. Openings in the forms shall also be provided where concrete placed above would leave accumulations of hardened concrete on reinforcing steel and form walls when making multiple pours.

ii) Concrete shall be worked into the corners and angles of the forms and around all reinforcement and embedded items without permitting segregation. Concrete shall be deposited as closely as possible to its final position on the forms. Placing of concrete in forms shall be done in horizontal layers approximately eighteen inches thick. When a monolithic layer cannot be completed in one operation, it shall be terminated as a vertical bulkhead with a height of newly placed concrete no less than six inches.

iii) Concrete during and immediately after placing shall be thoroughly compacted by mechanical vibration. Type and design of concrete vibrators shall be subject to review by the City Engineer. Frequency of vibration shall not be less than 4,500 impulses per minute. The intensity of vibrations shall be such as to visibly affect a mass of concrete over a radius of at least eighteen inches. The reinforcing shall not be vibrated, nor shall formwork be vibrated except in special cases and only with written authorization by the City Engineer. Insofar as is practicable, the stinger of the vibrator shall be inserted into the newly deposited concrete vertically and points of vibration and length of vibration shall be such as to completely work the concrete into all spaces within the form work and to allow the discharge of all entrapped bubbles of air. Vibration shall not be continued at any single point for such duration of time that localized areas of grout are formed. Vibration shall not be used to cause the concrete to flow in the forms to an extent where segregation becomes possible, nor shall vibrators be used for transport of concrete within the forms. Vibration shall be supplemented by such spading as is necessary to insure smooth surfaces and dense concrete along form surfaces and in corners and locations impossible to reach with the vibrators.

iv) Concrete shall be deposited at such a rate as to prevent the formation of cold joints in the pour. Should a sloping wall be placed in several lifts, the edges of succeeding pours shall not be feathered out, but blockouts shall be made in the top surface of the concrete in each lift to the extent that a minimum depth of six inches of concrete is deposited in each lift. Work shall not be stopped within eighteen inches of the top of any face unless natural features of the work indicate a discontinuity at which the pour line may be hidden. Concrete in columns shall be placed in one continuous operation unless otherwise directed. A time interval of at least twelve hours shall elapse before the caps are placed. Concrete in tee beam construction, or in slabs having integral beams, may be placed in two lifts or in one single operation. If the concrete is placed in one operation, it shall be placed in two stages. Concrete shall be deposited first in the stem of the beams and compacted. After the lapse of approximately 45 minutes the concrete in the slabs shall be placed. Vibration of the slab shall include inserting the probe of the vibrator at least half its length into the beam in order to thoroughly knit the two pours. If the concrete is placed to the top of the beams and allowed to harden before placing the slab, special care shall be used in insuring adequate bond between the stem and the slab. Shear keys shall be used as required, and the size and spacing of shear keys between the stem and slab shall be computed. Suitable keys may be formed by the use of wood blocks cut from two inch by four-inch dimension lumber having a length approximately four inches less than the width of the girder stem. These blocks shall be spaced along the girder stem as required to form keys, but the spacing shall be not greater than one-foot center to center. The blocks shall be leveled to facilitate removal from the concrete and shall be removed as soon as the concrete has set sufficiently to hold its form. No treatment shall be used on these blocks.

v) Prior to depositing new concrete on or against concrete which has achieved its initial set, the forms shall be retightened and the surface of the hardened concrete prepared to receive the new concrete in order that proper bond shall be made between the two pours. All foreign matter shall be removed. No loosened particles of aggregate or damaged concrete shall be left on the surface. Areas contaminated with form oils or any other material that would inhibit proper bonding between the pours shall be chipped away in such a manner which will not impair the integrity of that concrete which is left following the preparation for the new pour. To improve bond and to prevent the formation of unsightly pour joints, grout shall be placed on all concrete surfaces against which new concrete will be placed.

On horizontal surfaces approximately one inch of grout made by mixing sand and cement of the ratio in the concrete to be placed, mixed with just enough water to make possible proper placing shall be used. On vertical surfaces a neat cement slurry shall be broomed into the surface immediately prior to placing the next pour.

vi) The foundation upon which the Portland concrete is to be placed shall be properly compacted and brought to true line and grade as shown in the Contract Plans or as directed by the City Engineer. The foundation shall be frost-free and shall not have freestanding water pockets. Prior to placement of concrete the foundation shall be dampened to a depth of at least three inches. Concrete placed during raining conditions must be fully protected during the placing operation and for at least 24 hours after placing.

5. Finishing

a. General: The appearance of exposed concrete is of major importance. Concrete requiring finishing shall not be placed until materials, tools, and labor necessary for the work are on the job. All horizontal surfaces shall be steel trowel finished unless otherwise specified or otherwise authorized by the City Engineer in writing.

b. Walls: Immediately following the removal of forms, all form ties shall be broken back at least one half inch behind the finished face of the concrete and all form tie holes, all rock pockets and other defects pointed up with a dry tamped-in mixture of one part cement to two parts fine sand. Where pullout snap ties are used, the hole shall be filled as recommended by the manufacturer of the ties. The surface of the cavity to be patched shall be thoroughly wet before the patching mixture is applied. Following this, all form marks and pointings shall be ground or rubbed to give a reasonably smooth surface without pits, depressions or obvious irregularities and the surfaces then rubbed and sacked to a smooth even finish.

c. Floors and Roof Slabs: Slabs shall be finished as noted on the Plans or called out elsewhere in the Specifications. No dusting of wet surfaces with dry material shall be done unless specifically called out otherwise. Slabs shall be thoroughly compacted by tamping or by vibration. Preparatory to finishing, floor slabs shall be struck off true to the required level shown on the plans. Floors shall be level with a tolerance of 1/8 inch in ten feet except where drains occur, in which case the floors shall be pitched to the drains as indicated on the plans. All discontinuous edges shall be rounded off with a suitable edging tool. Unless otherwise specified, floors and slabs shall be finished by being wood floated to a true even plane with no coarse aggregate visible subsequent to being struck off. Sufficient pressure shall be used on the wood float to bring moisture to the surface. When surface moisture has disappeared, the concrete shall be hand-troweled to a smooth impervious surface free from trowel marks. The surface shall be burnished by a second troweling. The final troweling shall produce a ringing sound from the trowel. No dry cement shall be used in troweling nor shall the amount of troweling be excessive. Slabs receiving fill concrete or settling beds of mortar or grout surfacing shall be finished by tamping the concrete to force the coarse aggregate away from the surface, screeded to bring the surface to the required finish plane, and the surface left clean for subsequent work. Exterior slabs and ramps and any other surface called out on the Plans or in the Specifications as having a wood float surface shall be finished as for a steel-trowel finish, but the steel troweling not done. Where a broomed finish is specified or called out on the Plans, the concrete shall be finished as for steel-trowel finish except for the final troweling. The surface shall be finished by drawing a fine hair broom lightly across the surface. All brooming shall be

in the same direction and parallel to expansion joints or in the case of inclined slabs, perpendicular to the slope. Special surface finishes will be as described elsewhere in these Specifications or on the Approved Construction Plans.

i) Concrete slabs, the undersurfaces of which act as ceilings or overhangs and are exposed to view, shall have defects repaired and ground to a reasonably true and even surface prior to painting or other surface treatment specified on the Plans or elsewhere herein. Where no surface treatment is called out, care shall be taken to insure that the packing, pointing, or other repair is the same color as the rest of the exposed concrete.

6. Construction Joints

a. General: The locations of construction and expansion joints are indicated on the Plans. These may be changed upon request by the Contractor, but only upon approval by the City Engineer. Decisions in regards to construction joint changes will be based on the need for the joint at the place proposed and the final service requirements of the structure. The Contractor shall submit a schedule for the placement of all concrete outlining therein the sequence of his pouring operations and locations of all desired construction and expansion joints. Construction joints not indicated on the Plans must be made and located as to least impair the strength of the structure. The Contractor shall place no concrete prior to receiving approval of his schedule for placement of concrete.

i) Premolded joint fillers shall be placed in the forms at the proper position before concrete is placed and fastening devices used to hold it following the first pour. Unless otherwise indicated, expansion joints shall be formed by 1/4 inch thick premolded joint filler and in those areas indicated, the top 1/2 inch shall be removed and replaced by an approved asphaltic base expansion joint filler after appropriate priming of the joint in accordance with the expansion joint sealer manufacturer's specifications. Where a Thiokol base joint sealant is indicated on the plans, it shall be 1/4 inch thick and as approved by the City Engineer.

ii) Where contraction joints are indicated, 1/2 the steel through the joints shall be interrupted at the joint. Where waterstops are indicated, they shall be carefully positioned and held in place so that half the waterstop is located on each side of the joint centerline, special care being taken when placing concrete around them in order that all portions are equally and thoroughly embedded in the concrete. All construction joints in basins holding liquid or gas shall be provided with waterstops unless noted or shown otherwise on the Plans. Waterstops shall be held in place by the use of split forms or other approved methods in such a manner that no displacement will occur during the placing and compacting of the concrete. Nails may be driven into the forms and bent over the waterstop to hold it in position, but in no case shall any nail be driven through a waterstop.

iii) Asphaltic joint sealing compounds, which are poured in place, shall not be placed until all other concrete adjacent has been poured. Joints shall be thoroughly cleaned, dry and primed according to the asphalt-filler manufacturer's instructions before placement.

7. Blockouts

a. Unless otherwise noted, if the Contractor chooses to facilitate his operations by leaving blockouts in concrete walls where pipe or conduit pass through them, such will be allowed subject to review by the City Engineer. Blockouts shall be no larger than required to locate the pipe and/or conduit, in general, nor more than two inches larger than the largest dimension of the item passing through the wall. After the items are accurately placed and securely braced to prevent motion during subsequent operations, the contacting surfaces of the

previously placed concrete shall be prepared so as to insure proper bonding of the new concrete and that concrete previously placed. Where required, particularly in areas, which must withstand hydraulic pressure, a non-shrink aggregate such as Embeco shall be added to the mix used to fill the blockout. Such concrete shall be thoroughly compacted using vibration or rodding in order to achieve a watertight joint between the old concrete, the new concrete and the pipe or conduit. If a form is used for the closure, it shall be constructed having a pouring funnel and the new concrete so placed so that a portion remains in the pouring funnel and the surface ground to a smooth even face subsequent to the removal of the form. Where possible the placing of concrete and blockout shall be done from the pressure side. Special care shall be taken in such areas to keep them thoroughly wet for a period of at least seven days. With the City Engineer's review, blockouts may be dry packed using a non-shrink grout. The mixture shall be made up in accordance with the instructions of the manufacturer of the non-shrink aggregate and carefully tamped into place, preferably from the pressure side of the opening. Appropriate backing boards shall be provided to facilitate proper tamping. Blockouts in areas that are not required to withstand hydraulic pressure may be dry packed with a plain sand-cement mix.

8. Swept-In Surfaces

a. Where a concrete slab is to have grout swept in by a mechanism, such grout shall consist of a one to two ratio of Portland cement to sand mix with sufficient water to make possible its placing. Prior to placing any grout, all material shall be removed from the surface of the rough concrete slab receiving the topping and the surface thoroughly cleaned and washed. It shall be kept constantly wet for a period of at least 24 hours prior to the placing of grout. It shall be damp but have no standing water on it when a water-cement slurry is broomed into the surface. Before the slurry has a chance to take a set, the grout shall be placed and swept to the required contour by rotating the mechanism until the surface conforms accurately to the required contour. The mechanism manufacturer's instructions shall be strictly adhered to regarding the application of power during the screeding and sweeping in of the grout mix. Following this, the grout shall be steel troweled to a smooth even finish. When sufficiently hard, the entire surface shall be flooded and covered with water for a period of at least seven days. The surface shall be prevented from drying while hardening by dampening with a fine spray as required.

9. Curing, Sealer and Treatments

a. Curing: Concrete shall be kept moist for a period of at least seven days following placing where normal Portland cement (Type I) is used or three days when high-early strength cement (Type III) is used, unless otherwise specified. This may be accomplished by keeping the forms moist or applying an approved sealing compound or by flushing or sprinkling or otherwise applying water to the hardened concrete. In any case, the method used shall be subject to the City Engineer's approval.

10. Cold Weather Placement of Concrete

a. Adequate equipment shall be provided for heating the concrete materials and protecting the concrete during freezing or near-freezing weather. All reinforcement, forms, fillers and ground with which the concrete is to come in contact shall be free from frost. All cold weather concrete construction shall conform to the latest revision of the American Concrete Institute (ACI) standard ACI 306, Cold Weather Concreting.

11. Tests

a. Test Cylinders: Where there is a total of more than twenty cubic yards of concrete in the work or where the local building code requires, the Contractor shall take

four test cylinders for each fifty cubic yards of concrete placed or from each major pour if the amount is less than fifty cubic yards. Two test cylinders are to be cured under the job conditions and two in an approved commercial testing laboratory. Two cylinders shall be tested for compressive strength at seven days and two at 28 days. Making and curing the test cylinders shall conform to ASTM C-31, and testing shall conform to ASTM C-39. Two copies of all test reports shall be furnished to the Engineer by the testing laboratory.

i) If the concrete fails to meet the 28-day strength requirements, removal of the concrete may be required, or approved alternate strength tests may be permitted. Alternate tests, such as coring may be made upon approval by the City Engineer to determine the acceptability of the concrete in question.

b. Air Entrainment: The concrete shall be tested for the amount of entrained air therein according to the applicable ASTM specification.

c. Slump: Concrete will be tested for slump in accordance with ASTM C-143 at the job site by or under the direction of the Engineer. In general, the slump shall fall within the range indicated in the table below. At least one slump test shall be taken for each ready-mix truck of concrete.

Type of Work	Slump in Inches	
	Max	Min
Substructure walls and plain footings	3	1
Reinforced footings	4	2
Reinforced foundation walls	4	2
Reinforced slabs, walls and beams	4	2
Columns	4	2
Mass concrete more than three feet thick	2	1
Reinforced slabs	4	2
Fill Concrete	4	2

i) Concrete that exceeds the above maximum slumps may be rejected from the job and its removal ordered either before or after being placed in the forms.

18.08.020 Standard Concrete Curb and Gutter

A General

1. The Contractor shall perform all embankment, sub-base preparation, placing of gravel base, forming, placing, finishing, curing, cold weather placement if required, and backfill, associated with the construction of curb and gutter in conformity to the approved construction plans, and in accordance with the City of Hailey Standard Drawings and these Standard Specifications and to the lines and grades Established by the Engineer.

B Materials

1. Concrete shall conform to Section 18.08.018 of these Standard Specifications.

C Execution

1. Base under the curb and gutter shall be a compacted crushed gravel or rock and fill behind the curbs shall be a suitable approved excavated material compacted to a minimum of ninety-five percent (95%) of maximum density as determined by ASTM D698.

2. Excavation or embankment and subgrade preparation shall conform to Section 18.08.010 of these Standard Specifications.

3. Base construction shall conform to Sections 18.08.012 & 18.08.014 of these Standard Specifications.

4. The finish shall be a broom finish with the corrugations running parallel to the centerline.

5. The finished curb and gutter shall not vary from the true grade by more than 0.01 foot when tested with a ten (10) foot straightedge placed on top of the curb and in the gutter line parallel to centerline.

6. The curb and gutter shall be constructed to the line established by the Engineer to within 0.01 foot.

7. Combination curb and gutter shall be constructed in uniform sections a maximum of ten (10) feet in length, except where shorter sections are necessary for closures or on curves. Each section shall be separated by a contraction joint. Contraction joints shall be formed using a steel template, or may be cut or sawn. Each contraction joint shall have a minimum depth of two (2) inches and a width of three-sixteenths (3/16) inch maximum and one-eighth (1/8) inch minimum. The broom finish shall be carried over the contraction joint.

8. Premolded expansion joints shall be placed at terminal points of radii. The one half (1/2) inch joint filler shall be placed in the forms in the proper position before concrete is poured, and nails at about one feet on centers shall be driven through the filler so as to extend into the concrete when it is poured and hold the filler in position. All premolded joint fillers shall be neatly and accurately trimmed to match the contours of the surrounding concrete.

9. Cast in place curb and gutter forms shall be metal, straight, free from warp, and of sufficient strength to prevent displacement while placing the concrete. Where a section must be constructed on a curve, the section will be uniformly curved and not vary more than one-half (1/2) inch from true line.

10. Curb and gutter extruding type machines will be allowed provided line and grade can be maintained. Concrete shall be fed uniformly to the machine and be of such consistency that after extrusion the concrete will maintain the designated shape. Spacing of contraction and expansion joints shall be as previously specified.

18.08.022 Concrete Valley Gutter

A General

1. The Contractor shall perform all embankment, sub-base preparation, gravel base, forming, placing, finishing, curing, cold weather placement if required, and backfill, associated with the construction of a standard valley gutter section or surface cross drain in compliance with the approved construction plans and in accordance with the City of Hailey Standard Drawings and these Standard Specifications, and to the lines and grades established by the Engineer.

B Materials

1. All concrete shall conform to Section 18.08.018 of these Standard Specifications.

C Execution

1. Subgrade preparation shall conform to Section 18.08.010 of these Standard Specifications.

2. Gravel base shall conform to Section 18.08.014 of these Standard Specifications. The base shall be Type 1 Crushed Aggregate, and shall extend down to the bottom of the street section.

3. Valley gutter shall be constructed in uniform sections ten (10) feet in length except where shorter sections are necessary for closures. Each section shall be separated with a contraction joint as defined in Section 18.08.020 of these Standard Specifications.

4. Valley gutters shall be reinforced with a fibermesh product.

18.08.024 Storm Drainage and/or Irrigation Pipe

A General

1. The Contractor shall install drainage and/or irrigation pipe and all necessary structures in conformity with the approved construction plans and in accordance with the City of Hailey Standard Drawings and these Standard Specifications and to the lines and grades established. The work shall consist of trench excavation, trench preparation, pipe installation, pipe connection, structure installation and backfill complete.

B Materials

1. All pipe shall be Polyvinyl Chloride (PVC) pipe, rubber gasketed reinforced concrete pipe, water tight Corrugated Metal Pipe (C.M.P.), high density Polyethylene Pipe (HDPE), or approved equivalent of a class or gauge sufficient to withstand anticipated loads.

C Execution

1. Excavation and backfill shall conform to Section 18.12 of these Standard Specifications.

2. Drainage pipe to be used shall have a twelve (12) inch minimum diameter unless otherwise approved by the City Engineer. Culverts shall be constructed of corrugated metal pipe and shall have a twelve (12) inch minimum diameter unless otherwise approved by the City Engineer.

3. The drain system shall be designed so that water impounded in the streets will allow vehicle access during a one-hour, twenty-five (25) year storm and emergency vehicle passage for a one-hour, one hundred (100) year storm. Calculations shall be submitted to the City Engineer for approval prior to construction.

4. All special Irrigation or Drainage structures shall be designed by the Engineer at Owner/Developer expense and approved by the City Engineer prior to construction.

18.08.026 Concrete Catch Basins

A General

1. The Contractor shall construct catch basins in conformity with the approved construction plans and in accordance with the City of Hailey Standard Drawings, and these Standard Specifications. Precast concrete catch basins may be used with prior approval of the City Engineer.

B Materials

1. Concrete shall conform to Section 18.08.018 of these Standard Specifications.

C Execution

1. Excavation and backfill shall conform to Section 18.12 of these Standard Specifications.

2. Construction of catch basins shall include excavation, backfill, metal grates, concrete and any other incidentals, required to construct the structure.

18.08.028 Concrete Sidewalk

A General

1. The Contractor shall construct concrete sidewalk in conformity with the approved construction plans and in accordance with the City of Hailey Standard Drawings and these Standard Specifications. The work shall consist of all excavation, embankment, subbase preparation, gravel base, forming, placing, joint construction, finishing, curing, cold weather placement if required, and backfill, associated with the construction of concrete sidewalk as shown on the approved construction plans and the City of Hailey Standard Drawings or as designated by the City Engineer.

B Materials

1. Concrete shall conform to Section 18.08.018.

C Execution

1. Excavation and subgrade preparation shall conform to Section 18.08.010 of these Standard Specifications.

2. Gravel base construction shall conform to Section 18.08.014 of these Standard Specifications. The base shall be Type 1 Crushed Aggregate to the depths shown on the Hailey Standard Drawings.

3. The concrete finish shall be a broom finish with the corrugations running perpendicular to the centerline.

4. Sidewalk shall be constructed in uniform sections. Each section shall be separated with a contraction joint or expansion joint. Contraction joints shall be scored in a

straight line having a width of one-eighth (1/8) inch and a depth of three-quarters (3/4) inch. All edges of sidewalk and joints shall be rounded with an edging tool to a radius of one (1) inch.

5. Premolded expansion joint filler shall be installed in all sidewalks to provide expansion joints at not more than seventy-five (75) foot intervals and at all changes in direction or at intersections. Premolded joint filler shall also be used between sidewalk and other structures.

6. A contraction joint shall be constructed within one (1) foot of the junction between old sidewalk being retained and new sidewalk being constructed.

18.08.030 Drywell

A. General

1. This section covers the work necessary to construct a drywell and drain field for subsurface disposal of runoff water. The work shall be done in accordance with the City of Hailey Standard Drawing number 18.14.010.D.3.

B. Materials

1. The standard frame and cover shall be per Standard Drawing 18.14.010.C.3. Covers shall specifically say "STORM DRAIN". 2. Reinforced Concrete: The reinforced concrete shall be per Section 18.08.018.

3. Storm Drain Pipe: The PVC storm drain pipe which connects the catch basin to the dry well shall be twelve (12) inch minimum diameter and meet the requirements of ASTM D3034, SDR35.

4. Drain Rock: Drain rock shall be 1" minimum to 3" maximum clean, washed, pit-run uncrushed aggregate that conforms with the current edition of the Idaho Standards for Public Works Construction-Section 801-Uncrushed Aggregates.

5. Geotextile Filter Fabric: A Geotextile filter fabric shall meet AASHTO M288, Class 1, woven.

C. Workmanship

1. General: The drywell shall be constructed in accordance with Standard Drawing 18.14.010.C.3. Excavation and backfill shall be in accordance with Section 18.12. The storm drainpipe shall be installed in accordance with the applicable portions of Section 18.10.012.

2. Drainfield: The drainfields shall be constructed in accordance with the Hailey Standard Drawing No. 18.14.010.D.3. The drain rock shall be installed so that the aggregate is not contaminated with fines, which will slow the percolation rate or plug the drain rock. The drain rock shall be installed, with geotextile filter fabric on all sides, bottom and top before backfilling the trenches. The invert of the drywell shall be a minimum 11.0 feet below finished grade or at a depth required to place the drainfield in native sand and gravel.

3. Other alternative storm water disposal system may be allowed with prior approval by the City Engineer. Alternative storm water disposal system shall conform to the current edition of the "Catalog of Storm Water Best Management Practices" prepared by the Idaho Department of Environmental Quality.

18.08.032 Seal Coat

A. General

1. This item consists of placing an asphalt and aggregate seal coat on asphalt plantmix roadways and alleys in accordance with these specifications. All new roadways shall receive a seal coat prior to acceptance by the City of Hailey. Seal coats shall be installed within one year of completed roadway construction.

B. Materials

1. The grade of asphalt cement used shall be CRS-2R. The asphalt cement used shall comply with and be in accordance with sub-section 702.03 of the (2004) ITD Standard Specifications for Highway Construction, and the most recent supplemental specifications or revisions thereto. The asphalt cement shall be thoroughly blended with a minimum of 1.5 percent total rubber solids. The spread rate shall be from 0.35 - 0.40 gallons per square yard.

2. The mineral aggregate shall meet the following gradation requirements:

<u>Passing Sieve Size</u>	<u>% Passing by Weight</u>
1/2 inch	100
3/8 inch	40-90
No. 4	0-15
No. 8	0-5
No. 200	0-2

a. Aggregate shall have a cleanness factor of not less than 75. At least 70 percent by weight of the particles retained on the No. 4 sieve shall have one fractured face or more. The aggregate shall not show a loss of more than 30% in the Los Angeles Abrasion Test, Grading C. When tested in accordance with AASHTO T-182, aggregate shall have a retained film above 95 percent. Aggregate shall be applied at a rate of 28 pounds per square yard.

C. Workmanship

1. Asphalt shall not be applied when the roadway surface or weather conditions would prevent satisfactory construction. Seal coating shall not be undertaken unless the ambient temperature is above 70°F. and the pavement surface temperature is below 144° F., unless authorized in writing. Seal coats shall be applied no later than August thirty-first and not prior to June fifteenth of each year. Plantmix pavement shall cure a minimum of ten days before a seal coat is applied.

2. Roadways shall be clean and dried prior to asphalt application. Approaches shall be sealed before sealing the asphalt roadway. All cracks shall be routed and filled with approved material prior to application of the seal coat. Asphalt shall not be spread until the surface has been cleaned and the section to be sealed has been approved.

3. Asphalt shall be applied by means of a pressure distributor in a uniform, continuous spread over the section to be treated and within the temperature range specified. A strip of building paper three (3) feet wide and one (1) foot wider than the distributor spray bar shall be used at the beginning of each spread. If the cutoff is not positive, the use of paper may

be required at the end of each spread. The distributor shall be moved forward at proper application speed at the time the spray bar is opened. Any skipped areas or deficiencies shall be corrected. Junctions of spreads shall be carefully made to assure a smooth surface. The length of the asphalt spread shall not be in excess of that which trucks loaded with aggregate can immediately cover. Meet lines shall be allowed within one (1) foot of lane lines. Under no circumstances will meet lines be allowed within a wheel path. The spread of asphalt shall not be more than six (6) inches wider than the width covered by the aggregate from the spreading device. Under no circumstances shall operations proceed in such manner that the asphalt will be allowed to chill, set up, or otherwise impair retention of the aggregate. The distributor, when not spreading, shall be parked so that the spray bar or mechanism will not drip on the surface.

4. Immediately following the application of the asphalt, aggregate shall be spread in quantities as designated. Spreading shall be accomplished in such a manner that the tires of the trucks or aggregate spreader at no time contact the uncovered asphalt.

5. -If directed, the aggregate shall be moistened with water to eliminate or reduce the dust coating of the aggregate.

6. Immediately after the aggregate material is spread, deficient areas shall be covered by additional material. Rolling shall begin immediately behind the spreader and shall be continued until four complete coverages are obtained. Rolling shall be completed prior to allowing traffic to use the new surface. The Contractor's equipment shall not be operated at a speed that turns or displaces the aggregate. Only pneumatic tire rollers shall be used with a weight displacement of 200-350 pounds per inch of roller width. Turning of equipment, which displaces or turns the aggregate, will not be permitted. Prior to brooming, it may be necessary to apply approved reject material over the surface as directed to absorb any free asphalt. Excess aggregate shall be swept from the entire roadway surface by means of rotary brooms. Brooming shall be done by the morning following the previous day's seal coat application unless otherwise directed. Brooming shall be conducted so as not to displace embedded material. In curb and gutter section, excess material shall be picked up and disposed of as directed.

7. The brooms shall be in good condition and capable of sweeping a path at least seventy (70) inches wide without loosening or displacing embedded materials. The surface shall be swept when ordered.

8. Where brooming operations could create dust to the extent that it would violate air pollution regulations or create a safety hazard, the surface of the roadway to be swept shall be lightly sprayed with enough water to prevent dust from becoming airborne.

9. Brooming aggregate from the surface onto maintained shoulder-foreslope areas will not be permitted where the adjacent property owner cares for the area and maintains turf or landscape. All loose aggregate material shall be immediately swept, removed from the site and disposed of in a manner acceptable to the City of Hailey.

18.08.034 Silt Fences

A. General

1. Installation of erosion control silt fences and maintaining these fences throughout the construction period is required. Final construction design shall minimize future erosion and shall be in accordance with Hailey Standard Drawing 18.14.016.A.

B. Materials

1. Silt fences shall be of synthetic materials; pervious polypropylene, nylon,

polyester or polyethylene yarn; conforming to the following standards:

<u>Physical Property</u>	<u>Requirement</u>
Filtering Efficiency	75 – 85 % minimum
Tensile strength at 20% (maximum) elongation	Std strength – 360 lb/ft. Extra strength – 600 lb/ft.
Slurry flow rate	0.3 gpm/ft ²

2. Wire fences shall be 14 gauge minimum with 6 inch maximum spacing.
3. Posts shall be a minimum of 4 ft length of either 2 inches x 2 inches pine

or standard metal T-posts.

C. Execution

1. Provide silt fences near the perimeter of disturbed areas, along the toe of fills, on the downhill side of large cut-through areas, natural drainage areas, at grade breaks on cut/fill slopes or as shown on the construction drawings.
2. Construct silt fencing after tree removal and before any excavating or soil disturbing activities commence.
3. The fences must remain in place until the disturbed area is stabilized.
4. Design Configuration:
 - a. Maximum Drainage Area: 0.25 acres/100 feet of fence length.
 - b. Maximum Slope Steepness above Fence: 1:1 grade
 - c. Minimum Toe-in Depth: 6 inches
 - d. Post Spacing: 8 feet maximum with wire support fence, 6 feet maximum without wire fence (extra strength silt fence only)
 - e. Post Depth: 24 inches minimum
5. Refer to Section 18.14, Standard Drawings 18.14.016.A, for minimum construction standards.
6. Silt fences should be inspected periodically for damage and for the amount of sediment which has accumulated. Sediment shall be removed when it reaches one-half of the fence height.

Chapter 18.10

Water and Sewer Line Construction

Sections:

- 18.10.009 Water and Sewer Line Construction
- 18.10.010 Water Pipe Fittings, Valves, Fire Hydrants, Accessories
- 18.10.012 Sewer Pipe, Manholes and Related Work

18.10.009 Water and Sewer Line Construction

A. All work shall be in accordance with these City of Hailey Standard Specifications, the City of Hailey Standard Drawings, and the current edition of the Idaho Standards for Public Works Construction-Division-400-Water and Division-500-Sewer

18.10.010 Water Pipe, Fittings, Valves, Fire Hydrants, Accessories

A. General

1. The Contractor shall, at his option, use either polyvinyl chloride (PVC), or ductile iron water pipe that conforms to the specification. Ductile iron pipe shall be installed for Highway 75 undercrossings or at other locations as directed by the City Engineer. The minimum size water main shall be eight (8) inches, except for pipelines to fire hydrants, which shall be six (6) inches. The normal lengths of pipe shall be twenty (20) feet and of the sizes as shown on the approved construction plans. Random lengths shall not be less than 10 feet. All water mains shall have a minimum cover of not less than six (6) feet.

B. Material

1. Polyvinyl Chloride (PVC) Pressure Pipe
a. Polyvinyl Chloride (PVC) pipe sizes 6" to 12" shall be Class 150, DR 18 and shall conform to AWWA Standard C-900. PVC pipe, sizes 14" to 18" shall be Class 165, DR 25 and shall conform to AWWA Standard C-905. The pipe shall be the push-on type, unless otherwise specified on the approved construction plans, and conform to cast iron O.D.'s instead of IPS.

2. Ductile Iron Pipe
a. Ductile iron pipe shall be Class 51 and conform to AWWA C-151. Pipe joints shall be mechanical or push-on conforming with AAWA C-111. The interior shall have a cement mortar conforming with AWWA C-104.

3. Ductile Iron Fittings
a. Ductile iron fittings shall be made of ductile iron, which conforms to AWWA C 110 or AWWA C153, and be of the mechanical joint type unless specified otherwise on the approved construction plans. Gaskets and joints shall conform to AWWA C 111. The gasket configuration and installation shall be as recommended by the manufacturer of the particular pipe used.

4. Mechanical Joint Retainer Glands
a. Mechanical joint retainer glands shall be RomaGrip™ for PVC pipe as manufactured by Romac Industries, Inc. Installation shall be per manufacturers instructions. Set screw or lug type mechanical joints will not be allowed for use with PVC pipe.

5. Gate Valves

a. All gate valves shall meet the requirements of AWWA C 500 Specifications. The gate valves shall be two hundred (200) psi working pressure; double bronze mounted; non-rising stem with O-ring rubber gasket; and with a two (2) inch square operating nut, opening to the left. Valves shall be complete with cast iron bolts, nuts, rubber gaskets, and cast iron follower glands.

b. All gate valves shall be fitted with a standard adjustable cast iron valve box and lid. Valve boxes shall be Tyler 664A or approved equivalent.

c. All gate valves shall have mechanical joint ends, except at fittings where the valve shall be flanged to the fitting for thrust protection.

6. Fire Hydrants

a. All fire hydrants shall conform to AWWA C 502 Specifications. Hydrants shall have a six (6) foot bury; minimum five and one-fourth (5-1/4) inch diameter valve opening; one hundred fifty (150) psi working pressure; one (1), four and one-half (4-1/2) inch diameter National Standard Thread pumper nozzle; and two (2), two and one-half (2-1/2) inch diameter National Standard Thread fire hose nozzles. The valve operator will open left (counterclockwise). The hydrant shall be equipped with a breakable traffic flange, a drain that automatically opens when the hydrant is closed, and a six (6) inch diameter mechanical joint opening at the bottom to accommodate the six (6) inch diameter supply pipe. Fire hydrant materials and installation shall conform to the Hailey Standard Drawings.

b. The auxiliary gate valves shall conform to the applicable requirements of Section 18.10.0101, Paragraph B, sub-paragraph 5 of these Standard Specifications. The auxiliary gate valves shall be six (6) inch. The valve shall be flanged on one end to fit the flanged end of the tee in the water main, and the opposite end shall be furnished with a mechanical joint to fit the six (6) inch diameter supply pipe.

c. The valve boxes and covers provided shall conform to the requirements of Section 18.10.0101, Paragraph B, sub-paragraph 5 of these Standard Specifications.

d. Mechanical joint retainer glands shall be used to thrust protect fire hydrants. Concrete thrust blocks are prohibited.

7. Service Lines

a. Water service lines shall be either seamless copper water tube conforming to ASTM B 88, Type K or Polyethylene (PE) pressure pipe for Water Service conforming to AWWA C 901, Pressure Class 200 psi, DR 7, Iron Pipe Size.

b. All new service lines shall be 3/4-inch diameter unless documentation is submitted by the Engineer, which justifies a larger service size.

8. Water Meter Vaults

a. Water meter vaults shall be pre-piped for a 3/4" meter installation. The meter vaults shall provide for a minimum of 6' of cover at the service connection points. A 4" (four-inch) thick rigid insulation pad for inserting in the meter vault shall be included. Meter vaults shall be PVC pipe construction of a minimum thickness of .30". Meter vaults shall include a lockable metal cover rated HS-20. The cover provided shall include a 1-7/8" predrilled hole within a 4" diameter 3/8" recess for the radio read transmitter.

9. Health requirements

a. NSF-61 Compliance: All products in contact with potable water must comply with the requirements of NSF-61. Affidavits of compliance may be required.

C. Execution

1. Pipe Installation

a. All pipe and fittings shall be carefully inspected before being laid, and no cracked, broken, or defective pipe or fittings shall be used in the work. The ends of the pipe shall be cleaned with a brush, thoroughly scrubbed where necessary to remove dirt or other foreign material.

b. Extreme care shall be exercised to insure that the inside surfaces of the bell are smooth and free from any projections, which would interfere with the assembly or water-tightness of the joint.

c. Proper implements, tools, and facilities shall be provided and used by the Contractor for the safe and proper protection of the work. When such damaged pipe cannot be repaired to the satisfaction of the City Engineer or his representative, it shall not be used in the work. The pipe shall be carefully lowered in the trench to prevent damage to the pipe. Under no circumstances shall pipe be dropped or dumped into trenches. Foreign matter and dirt shall be removed from the inside of the pipe before it is lowered into the trench, and it shall be kept clean by approved means during and after laying.

d. Every precaution shall be taken to prevent foreign material from entering the pipe while it is being placed in the line. If the pipe laying crew cannot put the pipe into the trench and in place without getting earth into it, the City Engineer may require that, before lowering the pipe into the trench, a heavy, tightly woven canvas bag of suitable size shall be placed over each end and left there until the connection is to be made to the adjacent pipe. During laying operation, no debris, tools, clothing, or other material shall be placed in the pipe. The Contractor will not be allowed to deflect any individual joint of pipe greater than the manufacturer's maximum recommendations.

e. At times when pipe laying is not in progress, the open ends of the pipe shall be closed by a watertight plug or other means approved by the City Engineer or his representative, and no trench water shall be permitted to enter the pipe. This provision shall apply during the noon hour, work breaks as well as overnight. If water is in the trench, the seal shall remain in place until the trench is pumped free of any standing water.

f. A No. 12 AWG copper with insulation wire will be buried parallel to all PVC pipe and in the same trench, for the full length of the pipe. This tracer wire shall be wrapped at a minimum of 10-foot intervals for the full length of the pipe. Each run shall be brought to the surface inside the valve boxes for the gate valves. Ten linear feet of loose looped wire shall be left coiled in the valve box. All runs shall be electrically continuous between connections to valves.

g. Thrust blocks shall be placed as shown on the Approved Construction Plans and shall consist of concrete conforming to Section 18.08.18 of these Standard Specifications and Hailey Standard Drawing 18.14.010.B.4. Wrap all fittings with Polyethylene sheeting prior to placing concrete thrust blocks. The quantity of concrete and the area of bearing on the soil shall be as shown in the City of Hailey Standard Drawing 18.14.010.B.4 or as approved by the City Engineer. The thrust blocks shall be so placed that, unless specifically shown otherwise on the approved construction plans, the pipe and fitting joints will be accessible to repairs.

h. Valves shall be set and jointed to the pipe in the manner specified in the Fittings Section of these Specifications. A valve box shall be provided for each valve that is to be buried in the ground. The valve box shall not transmit shock or stress to the valve and

shall be centered and plumb over the wrench nut of the valve with the box cover flush with the surrounding surface, or such other level as may be directed by the City Engineer.

i. Valves shall be located as shown on the approved construction plans.

2. Connection to Existing System

a. Connections to the existing City of Hailey water system shall be made using the hot tap method wherever possible. The Water Superintendent shall determine whether to allow the shutdown of the city water main to facilitate installation of a fitting for the connection.

b. The Water Superintendent shall determine and inform the contractor on the method of disinfection to be followed if the installation of a fitting is allowed.

3. Hydrant Installation

a. Fire hydrants shall be located as shown on the approved construction plans in a manner to provide complete accessibility and to minimize the possibility of damage from vehicles or injury to pedestrians. Hydrants shall be located and constructed in conformance with the Hailey Standard Drawing 18.14.010.B.1 or 18.14.010.B.2. Thrust blocks for hydrants in lieu of mechanical restraints will not be allowed.

b. Where the hydrant is placed where lawn exists in the space between the curb and the sidewalk or between the sidewalk and the property line, no portion of the hydrant, pumper nozzle, or hose nozzle cap shall be within six (6) inches of the sidewalk or the face of the curb.

c. All hydrants shall stand plumb and have their nozzles parallel with or perpendicular to the centerline of the streets with the pumper nozzle facing the street. The hydrants shall be set to the grade established by the Engineer in conformance with the Hailey Standard Drawing 18.14.010.B.1 or 18.14.010.B.2.

d. Each hydrant shall be connected to the water main by a six (6) inch diameter supply pipe controlled by the auxiliary gate valve flanged to the water main.

e. Hydrant drainage shall be provided at the base of the hydrants by placing drain rock or crushed stone from the bottom of the trench to at least six (6) inches above the waste opening in the hydrant and to a distance of one (1) foot around the elbow. The drainage system shall not be connected to a sewer. The fire hydrants shall be set upon a stable aggregate material and a concrete base at least twelve (12) inches square by four (4) inches deep.

f. The bowl of each hydrant shall be thrust protected with mechanical pipe restraints as shown in the City of Hailey Standard Drawing 18.14.010.B.1 or 18.14.010.B.2 or directed by the City Engineer.

4. Water Service Installation

a. All new service lines will be one service per property, no branching in the service line will be allowed. Water service lines shall be constructed in accordance with the Hailey Standard Drawing 18.14.010.B.3.

b. Service line thawing cable installation shall be provided for all service connections. The electric service line thawing conductor shall be a single #6 copper cable, thermally insulated. The service line thawing cable installation shall be made in accordance with the City of Hailey Standard Drawing 18.14.010.B.3.

c. Prior to connecting the water service clamp to the water main the Contractor shall clean the exterior of the main of dirt or other foreign matter that may impair the quality of the completed connection. The Contractor shall provide the necessary tapping

machines for making the connections, and he shall furnish the miscellaneous materials required for making the taps. Place the service clamp at the desired location and clamp tight by tightening alternate nuts progressively. Do not place service clamp within 1 foot of pipe joint or other clamp. Taps shall be made in the pipe by experienced workmen using tools in good repair with the proper adapters for the size main being tapped. Copper tube for services shall be one piece for runs less than sixty (60) feet in length. All components of a service connection shall be the same size as the nominal designation of the service pipe. The copper tubing shall be cut with square ends, reamed, cleaned, and made up tightly. Care shall be taken to prevent the tube from kinking or buckling on short radius bends. Kinked or buckled sections of copper tube shall not be cut out and spliced. A new copper tube shall be installed from the corporation stop to the meter vault at the Contractor's expense.

d. Service connections installed during new construction shall be pressure tested with the water main. Service connections installed on existing water mains shall be pressure tested at the normal hydrostatic main pressure and visually inspected for leaks before backfilling. Service Connections shall be sterilized at the same time as the main line by opening the valve at the meter vault to flush, then closed.

e. Prior to backfilling, a steel fence post of sufficient length to extend at least 4 feet above finish grade shall be placed at the end of the completed service for a marker. The top of the post shall be spray painted blue.

5. Pressure Testing

a. Pressure and leakage tests shall be made on all newly laid pipe or any valved section of it, or both. The City Engineer will observe the tests, and the Contractor shall furnish all necessary equipment, labor, and material and shall make all taps in the pipe as required. The Contractor shall provide a minimum 24 hours notice to the City Water Superintendent prior to testing.

b. The Contractor will be required to furnish water for testing.

c. The tests shall be conducted after the trench has been backfilled.

Where any section of pipe is provided with concrete thrust blocking the pressure test shall not be made until at least five (5) days have elapsed after the concrete thrust blocking is installed. If high-early cement is used for the concrete thrust blocking, the time may be cut to two (2) days instead of the five (5) previously specified.

d. The pressure test shall be conducted in the following manner. After the pipe has been backfilled, the pipe shall be filled with water. The test pressure shall be one and one half (1-1/2) times the normal static pressure but not less than one hundred fifty (150) pounds per square inch.

e. The duration of each pressure test shall be a minimum of **two (2) hours**, or as specified by the City Engineer or his representative.

f. Before applying the specified test pressure, all air shall be expelled from the pipe.

h. Each valved section of pipe shall be slowly filled with water to replace any water lost; and the specified test pressure, measured at the point of lowest elevation, shall be applied by means of a pump connected to the pipe in a satisfactory manner.

i. The pump shall then be valved off, and the pressure shall be held in the line for the test period. At the end of the test period, the pump shall be operated until the test pressure is again attained. The pump suction shall be through a meter so that the amount of water required to restore the test pressure may be measured accurately.

j. Leakage shall be defined as the quantity of water necessary to restore the specified test pressure at the end of the test period. The pipe installation will not be accepted until the leakage is less than the number of gallons per hour as determine by the formula following:

$$\frac{L = ND (P)^{1/2}}{7400} \quad \text{in which}$$

- L = allowable leakage in gallons per hour
- N = number of joints in the length of pipe tested
- D = nominal diameter of pipe in inches
- P = average test pressure during the leakage test in pounds per square inch

i) Should any test of pipe laid disclose leakage greater than that allowed above, the Contractor shall, at his own expense, locate and repair the defective joints or pipe until the leakage is within the specified allowance.

6. Disinfection

a. Sterilization of new lines shall be completed by the Contractor prior to connection to the existing system. Only chemicals in conformance with NSF-60 shall be used.

b. Prior to chlorination, all dirt and foreign matter shall be flushed from the line. Water shall then be fed slowly into the new line with chlorine applied in amounts to produce a dosage of forty (40) to fifty (50) ppm. Treated water shall be retained in the pipe for at least twenty-four (24) hours. A residual of not less than twenty-five (25) ppm shall be produced in all parts of the line after the twenty-four (24) hour period.

c. Operate all valves, hydrants, and other appurtenances during sterilization to assure that the sterilizing mixture is dispersed into all parts of the line, including dead ends, new services, and similar areas that otherwise may not receive the treated water.

d. Chlorine tablets may be used with prior approval. Tablets shall be attached to the top of each pipe with PVC cement or honey. Adequate tablets shall be installed to provide a chlorine dosage of forty (40) to fifty (50) ppm.

e. After chlorination, flush the water from the line until the water through the line is equal chemically and bacteriologically to the permanent source of supply.

f. Dispose of sterilizing water in an approved manner. Do not allow sterilizing water to flow into a waterway without adequate dilution or other satisfactory method of reducing chlorine concentrations to a safe level.

g. After final flushing and before the water main is placed in service, test samples collected from the main(s) for coliform bacteria. Take 2 samples from each location at least 24 hours apart.

h. Unless otherwise directed by the Engineer, collect samples from each 1,200 feet of the new main and one from each branch.

i. The Contractor is directed to cooperate with the City in draining the water system after sterilization procedures are complete, and closing off dead end lines as directed by the City Engineer before filling the system with potable water.

7. Water and Sewer Main Crossings

a. When Water and Sewer Lines cross or services cross, refer to the current edition of ISPWC Standard Drawing 18.14.010.B.7, IDAPA 58.01.08.542.07.a and IDAPA 58.01.08.542.07.b which address the requirements for separation distances between potable water lines, including mains and service lines, with non-potable lines.

b. Under normal conditions a horizontal separation of at least ten (10) feet shall be maintained between water main and any sanitary sewer main, storm sewer, non-potable water line or sewer manhole. When a 10-foot horizontal separation cannot be provided, all of the following conditions shall be met:

i) The water main and sewer main shall be separated by at least six (6) feet at the outside walls.

ii) The water main must be at least eighteen (18) inches higher in elevation than the sewer main.

iii) The sewer main shall be constructed with pipe that meets water main standards and pressure tested for water-tightness; or the sewer main shall be encased with a sleeving pipe of material acceptable to DEQ standards.

c. For perpendicular sewer main and water main crossings, the water main shall normally be located above the sewer main with at least an 18 inch separation, and one full, uncut length of water pipe shall be centered over the crossing so that the joints are as far as possible from the sewer. If 18 inches of vertical separation cannot be maintained, the sewer main shall be constructed to water main standards and pressure tested for water tightness for a horizontal distance of ten (10) feet on both sides of the crossing, or either the sewer or water main must be encased with a sleeving pipe of material acceptable to DEQ standards for a horizontal distance of ten (10) feet on both sides of the crossing.

d. For perpendicular sewer main and water main crossings where the water main is below the sewer main, the following conditions shall be met.

i) When the water main and sewer main are separated by at least eighteen (18) inches, one full, uncut length of water pipe must be centered over the crossing so that the joints are as far as possible from the sewer, and the sewer main must also be supported above the crossing to prevent settling.

ii) When the water main and sewer main are not separated by at least eighteen (18) inches, the sewer main must be constructed to water main standards and pressure tested for water tightness for a horizontal distance of ten (10) feet on both sides of the crossing, or the sewer or water main shall be encased with a sleeving pipe of material acceptable to DEQ standards for a horizontal distance of ten (10) feet on both sides of the crossing; and the sewer main must also be supported above the crossing to prevent settling.

8. Cross Connection Control

a. There shall be no arrangement or connection by which any toxic or hazardous substance, domestic well water, or unapproved water systems may enter the City Domestic Water System.

b. Requirements for a Cross Connection Control Program are outlined in the Idaho Regulations for Public Drinking Water System latest edition, published by the Department of Environmental Quality.

18.10.012 Sewer Pipe, Manholes and Related Work

A. General

1. The Contractor shall use polyvinyl chloride (PVC) sewer pipe that conforms to the specification. The minimum size sewer main shall be eight (8) inches. The normal lengths of pipe shall be twenty (20) feet and of the sizes as shown on the approved construction plans. Random lengths shall not be less than 10 feet.

B. Materials

1. Polyvinyl Chloride (PVC) Pipe and Fittings

a. PVC gravity sewer pipe and fittings shall meet the requirements of ASTM D 3034. All pipe shall be SDR 35. Fittings such as prefabricated PVC tees, wyes, elbows, etc. shall be of the same material and compatible in construction with the adjacent pipe. Standard length shall be twenty (20) feet.

b. The pipe and fittings shall be made of PVC Plastic, which meets the requirements for Class 12454-B compound. The minimum physical properties and chemical resistance of the PVC compound shall meet the requirements of ASTM C 1784 for a Grade 1 compound.

c. All pipe shall be marked at intervals of no less than five (5) feet with normal pipe size, SDR number, Type, "Non-Potable Water", appropriate ASTM number, and working pressure.

d. The surface of the gasket shall be smooth and free of pits, cracks, blisters, air marks and other imperfections that would impair its use. Gasket strength shall be such that the gasket can be stretched to one hundred fifty percent (150%) of its normal circumference without harm to the gasket.

e. The bell shall be an integral part of the pipe section with the same strength. The rubber sealing ring shall meet the requirements of ASTM D-3212.

2. Manholes

a. Precast Manhole Sections. Precast concrete sections for manholes shall be a minimum forty-eight (48) inch inside diameter reinforced concrete pipe, Class II, conforming to ASTM C478, with the added requirement that the reinforcement shall be circular and not elliptical. Cones shall be eccentric with wall thickness and reinforcement similar to that of the manhole pipe sections. The tops and bottoms of cones shall be parallel. Precast manhole bases shall be ordered with pipe boots installed and either without a preformed trough or with a trough sized to the pipe diameter. The City Engineer shall approve rubber boots used for connecting to existing sewer mains.

b. Cast in place Concrete Base. Cast in place concrete manhole bases shall on be allowed upon approval by the City Engineer. Concrete used in the construction of the manhole base shall be so proportioned and mixed as to meet a three thousand (3,000) psi compression test after twenty-eight (28) days. There shall be a minimum of six (6) sacks of cement per cubic yard of concrete. Water shall be provided by the Contractor. Pipes installed into a cast-in-place manhole base shall have a double layer of an adhesive waterstop placed on the pipe prior to pouring the concrete. The gasket shall be approved by the City Engineer.

c. Manhole Section Joints. Joints shall be sealed with preformed plastic sealing gaskets, exterior wrap and non-shrink grout per Section 18.14, Hailey Standard Drawings 18.14.010.C.1 and 18.14.010.C.2.

i) Non-Shrink Grout: All grouting shall be done with non-shrink grout meeting ASTM Specification C-1107.

ii) Preformed Plastic Sealing Gaskets/Compounds: The sealing gasket/compound, shall be Type 1, Rope form of suitable cross-section and length as to

seal the joint space when the sections are put in place. The sealing compound shall be protected by a suitable removable two (2) piece wrapping without disturbing the other half to facilitate application of the gasket/ compound. The gasket shall be RAM-NEK manufactured by the Henry Company, Houston, Texas or approved equivalent.

iii) Exterior Wrap: The material shall be EZ-WRAP Rubber as supplied by PRESS-SEAL GASKET CORPORATION, Fort Wayne, Indiana or approved equal.

d. Manhole Extensions.

i) A thermoplastic concrete form, manufactured by The Whrlygig Company, Caldwell, Idaho, shall be used for manhole extensions. Concrete collar rings will be allowed only with the express permission of the City Engineer or Wastewater Superintendent.

ii) In general, manhole extensions having a minimum height of six (6) inches and a maximum height of twelve (12) inches will be used on all manholes except in cultivated fields and on very shallow manholes or in other locations where a subsequent change in grade may be unlikely as approved by the City Engineer.

e. Manhole Frames and Covers. All manhole frames and covers shall be of the size and shape detailed in Section 18.14, Standard Drawing 18.14.010.C.3. The word "SEWER" shall be cast into the top of the cover. Covers with inappropriate wording shall not be allowed.

f. Manhole and Alignment. Alignment of manholes with the sewer main, and manhole locations shall be in accordance with the City of Hailey Standard Drawings.

g. Steps are not allowed in sewer manholes. Holes from removed steps shall be grouted.

3. Lift Stations

a. Lift station shall be approved by the City Engineer. The Owner/Developer shall be responsible for all costs associated with engineering review of lift stations.

a. Lift station manholes shall conform to the requirements of Section 18.10.012, Paragraph B, sub-paragraph 2 and Paragraph C, sub-paragraph 4(b).

b. Control of lift station operation shall be PLC based, radio signal operated, conforming to the City of Hailey current software and shall be approved by the Wastewater Superintendent.

C. Execution

1. Pipe.

a. All pipe and fittings shall be carefully inspected before being laid, and no cracked, broken, or defective pipe or fittings shall be used in the work. The ends of the pipe shall be cleaned with a brush, washed, and thoroughly scrubbed where necessary to remove dirt or other foreign material.

b. Extreme care shall be exercised to insure that the inside surface of the bell is smooth and free from any projections, which would interfere with the assembly or water tightness of the joint.

c. Proper implements, tools, and facilities shall be provided and used by the Contractor for the safe and proper protection of the work. When such damaged pipe cannot be repaired to the satisfaction of the City Engineer or his representative, it shall not be used in the work. The pipe shall be carefully lowered in the trench to prevent damage to the pipe. Under no circumstances shall pipe be dropped or dumped in trenches. Foreign matter and

dirt shall be removed from the inside of the pipe before it is lowered into the trench, and it shall be kept clean by approved means during and after laying.

d. Maximum deviation from true line or grade shall be three-eighths (3/8) inch.

e. Measurement for grade shall be taken at the pipe invert, NOT AT THE TOP OF PIPE, because of permissible variation in pipe wall thickness.

f. Grade and line shall be established from batterboards set along the trench at maximum fifty (50) foot intervals or a Laser. The Engineer shall provide offset stakes for the line and grade of the sewer main.

g. Sufficient pressure shall be applied in making the joint to assure that the joint is home as defined in the standard installation instructions provided by the pipe manufacturer. Sufficient restraint shall be applied to the line to assure that joints, once home, are held so by tamping fill material under and alongside the pipe or otherwise. At the end of the day's work, the end of the last pipe shall be blocked in such a manner as may be required to prevent creep and shall be tightly plugged to prevent entrance of dirt, vermin, or debris into the pipe.

2. Manholes.

a. The concrete base for the precast manhole shall be constructed so that the first section of the precast manhole has a uniform bearing throughout the full circumference of the manhole wall. Sufficient mortar shall be deposited on the concrete base to provide a watertight seal between the base and the manhole wall. Pipe shall not be inserted into manhole bases in manner that negatively affects the performance of any gaskets or creates an obstruction to smooth flow.

b. Preformed plastic sealing gaskets, shall be placed on the groove of the lower section of pipe prior to placing the next section of pipe. After all the sections are in place, the excess sealing compound shall be trimmed off prior to finishing. The entire joint shall be filled with mortar and troweled to a smooth finish.

c. The cast iron manhole frames and covers shall be installed and grouted on the tops of the manhole so as to positively prevent any infiltration of surface or ground water into the manholes. The manhole frame and concrete collar shall be set using WhirlyGIGs as shown in the Hailey Standard Drawing 18.14.010.C.1. Pipe clamps on rubber boots shall be torqued to the manufacturer's specifications (60 in/lb. typ.).

3. Sewer Service Connections:

a. Sewer service connection shall be constructed and located in accordance with the Approved Construction Plans and Hailey Standard Drawings. Service connections to the main shall be wyes for all new construction. Services shall not be connected to manholes. To the greatest extent possible services shall be laid perpendicular or radial to the street from the center of the lot to the sewer main. Install the sewer wye so as to locate the connection pipe within a horizontal distance of one foot either side of the preselected locations staked by the Engineer. Batter boards will not be required, but lay the pipe uniformly between the wye or the top of the riser section and the stake. Where minimum slopes are used, lay the pipe by means of a good-quality builder's level, not less than 24 inches in length. Minimum slope shall be 1/4 inch per foot unless otherwise permitted by the City Engineer, but in no case less than 1/8 inch per foot.

b. Wye size shall be four inch diameter for single service unless otherwise indicated on the Approved Construction Plans and shall be terminated with a bell and

plug. The plug shall be an approved PVC plug or a neoprene plug. Tees are not permitted for service connections to sewer mains.

c. In some instances where the sewer main is deeper than required for a specific service connection, the service stub may be set either vertically or at 45° with one or more sections of straight pipe placed prior to the 1/8 bend. When the service stub is set vertically, there will be required a 1/4 bend in place of the 1/8 bend.

d. The Contractor is cautioned to use extreme care in backfilling around the sewer service connection and sewer service pipe to assure a watertight joint when complete. The sewer service connection and its sewer service pipe extension shall be included in the air or hydrostatic test of the main sewer pipe.

e. Sewer Service connections to existing sewer pipe shall be made with Romac Universal CB Sewer Saddle or equivalent.

f. A steel fence post of sufficient length to extend at least four (4) feet above finished grade shall be placed at the end of the completed service for a marker. The top of the post shall be spray painted green. A #12 copper wire, thermally insulated shall be tied to the bottom of the post and attached to the end of the sewer service.

g. Backfill shall not be done until both the Engineer and the Contractor have made accurate field measurements, as to the exact location of each service connection for filing on the Record Drawings.

h. All excavation and backfill shall be done in accordance with Section 18.12 Excavation and Backfill.

4. Tests and Inspections. Following backfill all pipes will be tested for deflection with a five percent tolerance "Go-No-Go" gauge. All pipe failing the test shall be reinstalled.

a. Air Tests for Sewer Lines:

i) The Contractor shall air test all of the sewer lines after backfilling and compacting of the trenches and shall furnish all equipment and personnel required to perform the tests.

ii) To facilitate the detection of any leaks that may have occurred during the pipe laying operation, the Contractor may, at his option, air test any or all of the sewer lines prior to backfilling. However, this test will be in addition to the required air test following the backfilling and compaction of the trench.

iii) The low-pressure air test is a test that determines the rate at which air under pressure leaves an isolated section of pipeline. This rate indicates the presence or absence of pipe damage and/or pipe or poor quality. The test procedure is described as follows:

iv) The section of pipe to be tested is plugged at each end. The ends of all branches, laterals, and wyes which are to be included in the test are sealed or plugged. All plugs shall be carefully braced to prevent slippage and blowout due to internal pressure. One of the plugs provided must have an inlet tap or other provision for connecting an air hose.

v) Connect one end of the air hose to the inlet tap on the plug and connect the other end of the hose to portable air control equipment. The air control equipment shall consist of pressure gauges and valves used to control the rate at which the air flows to the test section and to monitor the air pressure inside the pipe. The air control equipment can then be connected to a source of air supply such as a portable air compressor.

vi) After the air hoses are properly connected, inject air into the test section. Monitor the air pressure so that the pressure inside the pipe does not exceed five psi; gauge (psig).

vii) When the pressure inside the test section reaches 4.0 psig, throttle the air supply so that the internal pressure is maintained between 4.0 and 3.5 psig for at least two minutes. These two minutes allow time for the temperature of the air to come to equilibrium with the pipe walls.

viii) After the temperature has been allowed to stabilize for the two-minute period, the air supply should be disconnected, and the pressure allowed to decrease to 3.5 psig. At 3.5 psig a stopwatch is to be started to determine the time required for the pressure to drop to 3.0 psig.

ix) The section of pipeline being tested shall be considered acceptable if the time required in seconds for the pressure to decrease from 3.5 to 3.0 psig is equal to or greater than that shown in Table I, the current edition of the ISPWC Specifications, Section 501 – Gravity Sewers.

x) The Contractor shall provide a minimum of 24 hours notice to the City Wastewater Superintendent prior to testing.

b. Manhole Leakage Test. One of the following tests shall be performed:

i) Hydrostatic Testing:

(1) When the ground water table is too low to permit visual detection of leaks, project manholes may be required to be hydrostatically tested. The City Engineer shall determine if this test will be performed. The test shall consist of plugging all inlets and outlets and filling the manhole with water to a height determined by the City Engineer. Leakage in each manhole shall not exceed 0.1 gallon per hour per foot of head above the invert. A manhole may be filled 24 hours prior to time of testing, if desired, to permit normal absorption into the pipe walls to take place. Repair all manholes that do not meet the leakage test, or are unsatisfactory from visual inspection, to conform to the requirements herein.

ii) Vacuum Testing:

(1) Vacuum testing shall conform to the latest edition of the ISPWC standards, Section 502 – Manholes.

c. Final Sewer Cleaning:

i) Prior to final acceptance and final televised manhole-to-manhole inspection of the sewer system by the Engineer, flush and clean all parts of the system both pressure and gravity. Remove all accumulated construction debris, rocks, gravel, sand, silt, and other foreign material from the sewer system at or near the closest downstream manhole. If necessary, use mechanical rodding or bucketing equipment.

ii) Upon the Engineer's final manhole-to-manhole inspection of the sewer system, if any foreign matter is still present in the system, clean the sections and portions of the lines as required.

d. TV Inspection:

i) The City shall perform a televised inspection of the installed sewer main upon 24 hour notice from the contractor. A dye will be introduced into the pipe during the videotaping. Any sag in the pipe greater than ½" shall be corrected.

5. Connection to Existing Manholes:

a. Pipes connected to existing manholes will not be allowed to enter above the shelf such that sewage will flow across the shelf prior to entering the channel of the manhole. The existing manhole base must be core drilled such that the new pipe will enter the manhole with the invert of the new pipe 0.1 foot above the invert of the channel. A rubber boot, approved by the City Engineer will be required for the new pipe. A new channel shall be constructed from the new pipe to the existing channel. The new channel shall be finished with grout to provide smooth flow into and through the existing manhole.

6. Special Manhole.

a. Construct special manholes in conformance with applicable portions of these specifications and as shown on the Hailey Standard Drawing 18.14.010.C.2.

7. Inter-Connection Control.

a. There shall be no physical connection between a public or private potable water supply system and a sewer, or appurtenance thereto which would permit the passage of any sewage or polluted water into the potable supply.

b. Requirements for a Cross Connection Control Program are outlined in the Idaho Regulations for Public Drinking Water System latest edition, published by the Department of Environmental Quality.

Chapter 18.12

Excavation and Backfill

Sections:

18.12.010 Excavation and Backfill

18.12.010 Excavation and Backfill

A. General

1. This section includes the requirements for excavation, pipe bedding and backfilling for pipelines, services and appurtenances.

B. Materials

1. Type I Pipe Bedding. shall be in accordance with Type I Pipe Bedding per the current edition of the Idaho Standards for Public Works Construction-Section 305-Pipe Bedding Pea gravel and poorly or uniformly graded crushed stone shall not be allowed.

2. Type II Pipe Bedding. shall be in accordance with Type II Pipe Bedding per the current edition of the Idaho Standards for Public Works Construction-Section 305-Pipe Bedding

C. Execution.

1. Clearing the Right-of-Way.

a. Where clearing of the right-of-way is necessary, it shall be completed prior to the start of the trenching. Brush shall be cut as near to the surface of the ground as practicable and removed to an approved disposal area. The Contractor shall observe all Federal and State laws relating to hauling permits and local regulations relating to burning and/or otherwise disposing of such materials. Under no conditions shall excavated materials be permitted to cover brush prior to clearing and removing same.

2. Obstructions.

a. This item shall refer to obstructions that may be removed and do not require replacements. Obstructions to the construction of the trench such as but not limited to tree roots, stumps, abandoned concrete structures, and debris of all types shall be removed by the Contractor. The City Engineer may, if requested by the Engineer, allow changes in alignment to avoid major obstructions if such alignment changes can be made without adversely affecting the intended functioning of the facility.

3. Removal of Topsoil.

a. In all cases where trenches cross cultivated fields or other areas on which topsoil exists, the topsoil shall first be removed for the depth of twelve (12) inches for the full width of the trench to be excavated. This topsoil shall be stockpiled to one side of the right-of-way and not mixed with the remaining excavated material. The topsoil shall be replaced in the top one (1) foot of the backfilled trench.

b. The surface of the trench and other disturbed areas shall be brought to a true and even grade to match the adjacent lawn or cultivated areas. All rocks, debris, roots, clods, and deleterious material unearthed or encountered shall be removed and disposed of. The finished surface shall be free from humps, depressions, and other irregularities.

4. Trenches.

a. Trench excavation shall be to line and grade as established by the Engineer. The bottom width of the trench shall be as shown on the City of Hailey Standard Drawings for the size of pipe installed.

b. The trenches shall be adequately and properly timbered or shored and constructed in conformance with all applicable regulations. It shall be the Contractor's responsibility to provide and install all shoring, sheeting, and bracing and he shall be responsible for the adequacy of the same. Where the bottom of the trench encounters a material which, in the opinion of the City Engineer or his representative, is unstable and not adequate to provide a suitable foundation for the pipe, the trench shall be over-excavated to remove the unstable material and then backfilled with an approved pipe bedding material to bring the bottom of the trench back up to grade. Excavation shall extend to at least four (4) inches below the line of the pipe bell and then backfilled with an approved pipe bedding material to form a cradle for the pipe. The final or finished grade, including bell holes, shall be made just ahead of pipe laying. All irregularities in the trench bottom shall be removed by appropriate excavation and backfilled to provide a minimum of four (4) inches of pipe bedding material under the pipe. Bell holes shall be excavated for bell and spigot pipe of sufficient dimensions to permit pipe laying to work freely and to positively avoid the bell carrying any weight or loading stresses and so that the pipe shall have a firm bearing of not less than three-fourths (3/4) of the length of the barrel. Trenches shall be kept free of water until the pipe is laid, joints completed, and thereafter until jointing material is adequately set.

5. Location of Excavated Materials.

a. During trench excavation, the Contractor shall locate the excavated material so it will not completely obstruct a traveled street or roadway. Unless otherwise approved by the City Engineer, all streets and roadway shall be kept open to at least one-way traffic.

6. Removal of Water.

a. The Contractor shall provide and maintain ample means and devices with which to promptly remove and dispose of all water entering the trench excavation during the time the trench is being prepared for the pipe laying, during the laying of the pipe, and until the backfill at the pipe zone has been completed. The Contractor shall dispose of the water in a suitable manner without damage to adjacent property, drainage ways, or irrigation ditches.

7. Gravel Bedding for Foundation Stabilization.

a. If trenches are hampered by unstable, wet parent material or excessive water on the bottom, the trench shall be over-excavated and material that meets the requirements of Type II Pipe Bedding per the current edition of the Idaho Standards for Public Works Construction-Section 305-Pipe Bedding shall be placed for pipe subgrade. Once the pipe is placed on the bedding and the compaction and stability of the bedding material approved by the City Engineer, initial backfill may commence.

8. Initial Backfill.

a. After the pipe lengths have been jointed and jointing material has been properly set to the City Engineer's or his representative's approval for backfilling, the bell holes and sides of the pipe shall be carefully backfilled with pipe bedding material and thoroughly compacted with approved tampers. The Contractor shall exercise care in placing the initial backfill to insure the pipe remains centered in the trench. Initial backfill material shall contain no particle larger than one (1) inch for all sizes of pipe. The initial backfill shall be continued in layers of not to exceed six (6) inches in thickness until the backfill is six (6) inches

above the top of the pipe using approved pipe bedding material. Each layer of backfill shall be compacted to a minimum of ninety-five percent (95%) of maximum density as determined by ASTM D 698, as shown on the City of Hailey Standard Drawings. A copy of the soil inspection report from a certified inspector for this requirement shall be provided to the City Engineer. A minimum of one test per 250 feet of installed pipe shall be performed. Compaction tests shall be performed at the Contractor/Developer's expense. Under no conditions will puddling be permitted for this initial backfill.

9. Trench Backfill.

a. After initial backfill, trenches may be backfilled with the material excavated provided rocks larger than eight (8) inches and other deleterious material, if present in the excavated material, are removed. Material containing frost shall not be used for backfill. The first one (1) foot of backfill above the initial backfill shall be given careful attention as to composition. The backfill shall be placed in horizontal lifts. The entire backfill shall be firmly compacted by mechanical methods approved by the City Engineer or his representative. Compaction shall be to a minimum of ninety-five percent (95%) of the maximum density as determined by ASTM D698. A copy of the soil inspection report from a certified inspector for this requirement shall be provided to the City Engineer. A minimum of one test per 250 feet of installed pipe shall be performed per lift. Compaction tests shall be performed at the Contractor/Developer's expense.

10. Excess Excavated Material.

a. All excess excavated materials from excavation and backfill operations shall be hauled and disposed of by the Contractor at locations obtained by the Contractor.

11. Surface Runoff Water.

a. The Contractor shall at all times protect any open trench from the entrance of surface runoff water within the work area. In the event that water does enter a trench, the City Engineer or his representative may require the Contractor to furnish foundation stabilization gravel to provide a suitable foundation for laying the pipe.

Chapter 18.14

Standard Drawings

Sections:

- 18.14.010 Water and Sewer
- 18.14.012 Street and Drainage
- 18.14.014 Miscellaneous
- 18.14.016 Storm Drainage

18.14.010 Water and Sewer

- A. Trench Section
 - 1. Trench and Surface Repair
 - 2. New Development Typical Trench Selection
- B. Water Section
 - 1. Fire Hydrant Detail Residential Street Option 1
 - 2. Fire Hydrant Detail Residential Street Option 2
 - 3. Residential Water Service Connection
 - 4. Thrust Blocking For Water Main Fittings
 - 5. Typical Water and Sewer Layout
 - 6. Water Pipe Laying
 - 7. Potable and Non-Potable Water Line (NPWL) Separation
 - 8. Irrigation System Double Check Valve
- C. Sewer Section
 - 1. Sewer Manhole (Type A)
 - 2. Special Sewer Manholes
 - 3. Manhole Cover & Frame
 - 4. Sewer Service Connection
 - 5. Sewer Backwater Valve
 - 6. Sewer Pipe Laying
 - 7. Pipe Support Across Trench
- D. Storm Section
 - 1. Catch Basin
 - 2. Catch Basin Inlet Grate and Frame Detail
 - 3. Drywell
 - 4. Sand and Grease Trap

- 18.14.012 Street and Drainage
- A. Typical Curb Gutter and Sidewalk
 - B. Concrete Driveway Approaches
 - C. Pedestrian Ramp
 - D. Typical Valley Gutter
 - E. Sidewalks at Intersections
 - F. Street Sections
 - 1. Curbed Street Section
 - 2. Typical Street Section
 - G. Street Widening
 - H. Parking
 - 1. On-Street Parking Standards
 - 2. On-Site Parking Standards
 - I. Typical Parking Lot Section
 - J. Standard Shared Use Path
 - K. Driveway Approaches
 - 1. Without Sidewalk
 - 2. With Sidewalk
 - L. Street Radius

- 18.14.014 Miscellaneous
- A. Type I Survey Monuments
 - B. Street Terminus Barricade
 - C. Typical Utility Locations
 - D. Street Signs
 - E. Light Pole & Pedestal Details
 - F. Tree Grate Detail

- 18.14.016 Storm Drainage
- A. Silt Fence

Section 2. All City of Hailey ordinances or resolutions or parts thereof, which are in conflict herewith, are hereby repealed.

Section 3. This ordinance shall be in full force and effect from and after the required three (3) readings, approval, and publication according to law.

PASSED AND ADOPTED BY THE HAILEY CITY COUNCIL AND APPROVED BY THE MAYOR THIS ____ DAY OF _____, 2012.

Fritz X. Haemmerle, Mayor

Attest:

Mary Cone, City Clerk

Publish: Idaho Mountain Express _____, 2012

